

Features

- Non-Isolated Design with Low Residual Output Voltage < 2kV
- No Afterglow
- Ultra High Efficiency (Up to 97.0%)
- Full Power at Wide Output Current Range (Constant Power)
- Adjustable Output Current (AOC) with Programmability
- Isolated 0-10V/10V PWM/Resistor/3-Timer-Modes Dimmable
- Dim-to-Off with Standby Power ≤ 0.5W
- Maximum Dimming Level with 9V or 10V Selectable
- Fade-time Adjustable
- Always-on Auxiliary Power: 12Vdc, 250mA
- Low Inrush Current
- Output Lumen Compensation
- End-of-Life Indicator
- Input Surge Protection: DM 4kV, CM 6kV
- All-Around Protection: OVP, SCP, OTP
- IP65 and UL Dry/Damp Location (MF models)
- IP66/IP67 and UL Dry/Damp/Wet Location (MG/MT models)
- Suitable for Luminaires with Protection Class I
- 5 Years Warranty



Description

The NEL-400SxxxMx series is a 400W, constant-current LED driver that operates from 180-457 Vac input with excellent power factor. It is created for many lighting applications including high bay and horticulture, etc. The high efficiency of these drivers and slim metal case enables them to run cooler, significantly improving reliability and extending product life. To ensure trouble-free operation, protection is provided against over voltage, short circuit, and over temperature.

Models

Adjustable Output Current Range(mA)	Full-Power Current Range(mA) ⁽¹⁾	Default Output Current(mA)	Output Voltage Range(Vdc)	Max. Output Power(W)	Typical Efficiency ⁽²⁾	Typical Power Factor ⁽²⁾	Model Number ⁽³⁾⁽⁴⁾
73-1400	730-1400	1400	150-550	400	97.0%	0.97	NEL-400S140Mx

- Notes:** (1) Output current range with constant power at 400W
 (2) Measured at 100% load and 400Vac input (see below "General Specifications" for details).
 (3) Certified voltage range: 200-415Vac
 (4) x = F are UL Class P, ENEC, CE, etc. models with flying leads; x = G are UL Recognized, ENEC, CE, etc. models; x = T are UL Class P models. See below "Mechanical Outline" for details.

I-V Operation Area

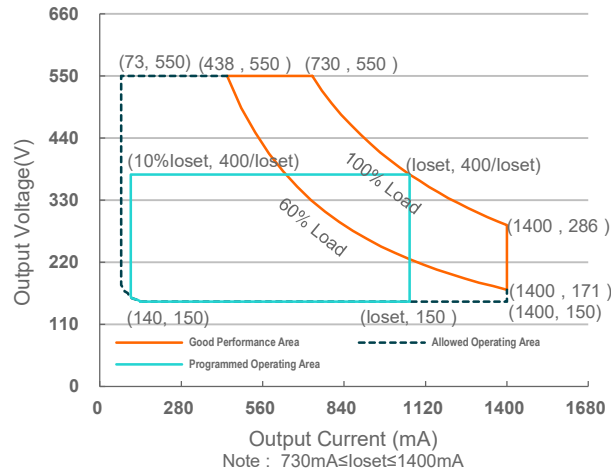

Input Specifications

Parameter	Min.	Typ.	Max.	Notes
Input AC Voltage	180 Vac	-	457 Vac	
Input DC Voltage	255 Vdc	-	400 Vdc	
Input Frequency	47 Hz	-	63 Hz	
Leakage Current	-	-	0.75 MIU	UL 8750; 415Vac/60Hz
	-	-	0.70 mA	IEC 60598-1; 415Vac/ 60Hz, grounding effectively
Input AC Current	-	-	2.34 A	Measured at 100% load and 200 Vac input.
	-	-	1.17 A	Measured at 100% load and 400 Vac input.
Inrush Current(I ² t)	-	-	0.91 A ² s	At 415Vac input, 25°C Cold Start, Duration =7.04 ms, 10%I _{pk} -10%I _{pk} .
PF	0.90	-	-	At 200-415Vac, 50-60Hz, 60%-100% Load (240-400W)
THD	-	-	20%	
THD	-	-	10%	At 220-240Vac, 50-60Hz, 75%-100% Load (300-400W)

Output Specifications

Parameter	Min.	Typ.	Max.	Notes
Output Current Tolerance	-5%loset	-	5%loset	At 100% load condition
Output Current Setting (loset) Range				
NEL-400S140Mx	73 mA	-	1400 mA	
Output Current Setting Range with Constant Power				
NEL-400S140Mx	730 mA	-	1400 mA	

Output Specifications (Continued)

Parameter	Min.	Typ.	Max.	Notes
Total Output Current Ripple (pk-pk)	-	5%I _o max	10%I _o max	At 100% load condition, 20 MHz BW
Output Current Ripple at < 200 Hz (pk-pk)	-	2%I _o max	-	At 100% load condition. Only this component of ripple is associated with visible flicker.
Startup Overshoot Current	-	-	10%I _o max	At 100% load condition
No Load Output Voltage NEL-400S140Mx	-	-	600 V	
Line Regulation	-	-	±1%	Measured at 100% load
Load Regulation	-	-	±5%	
Turn-on Delay Time	-	-	0.5 s	Measured at 200-415Vac input, 60%-100%load
Temperature Coefficient of I _o set	-	0.06%/°C	-	Case temperature = 0°C~T _c max
12V Auxiliary Output Voltage	10.8 V	12 V	13.2 V	
12V Auxiliary Output Source Current	0 mA	-	250 mA	Return terminal is "Dim"
12V Auxiliary Output Transient Peak Current@6W	-	-	500 mA	500mA peak for a maximum duration of 2.2ms in a 6.0ms period during which time the average should not exceed 250mA.
12V Auxiliary Output Transient Peak Current@10W	-	-	850 mA	850mA peak for a maximum duration of 1.3ms in a 5.2ms period during which time the average should not exceed 250mA.

General Specifications

Parameter	Min.	Typ.	Max.	Notes
Efficiency at 220 Vac input: NEL-400S140Mx I _o =730 mA I _o =1400 mA	93.5% 93.0%	95.5% 95.0%	- -	Measured at 100% load and steady-state temperature in 25°C ambient; (Efficiency will be about 2% lower if measured immediately after startup.)
Efficiency at 277 Vac input: NEL-400S140Mx I _o =730 mA I _o =1400 mA	94.5% 94.0%	96.5% 96.0%	- -	Measured at 100% load and steady-state temperature in 25°C ambient; (Efficiency will be about 2% lower if measured immediately after startup.)
Efficiency at 400 Vac input: NEL-400S140Mx I _o =730 mA I _o =1400 mA	95.0% 94.5%	97.0% 96.5%	- -	Measured at 100% load and steady-state temperature in 25°C ambient; (Efficiency will be about 2% lower if measured immediately after startup.)
Standby power			0.5W	Measured at 230Vac/50Hz; Dimming off
MTBF	-	405,000 Hours	-	Measured at 400Vac input, 80%Load and 25°C ambient temperature (MIL-HDBK-217F)
Lifetime	-	120,000 Hours	-	Measured at 400Vac input, 80%Load and 70°C case temperature; See lifetime vs. T _c curve for the details
	-	120,000 Hours	-	Measured at 220Vac input, 100%Load and 40°C ambient temperature
Operating Case Temperature for Safety T _c s	-40°C	-	+90°C	

General Specifications (Continued)

Parameter		Min.	Typ.	Max.	Notes
Operating Case Temperature for Warranty T _{c w}		-40°C	-	+80°C	Case temperature for 5 years warranty. Humidity: 10% RH to 95% RH
Storage Temperature		-40°C	-	+85°C	Humidity: 5% RH to 95% RH
Dimensions	MF models Inches (L × W × H) Millimeters (L × W × H)	16.97 × 1.69 × 1.50 431 × 43 × 38			With mounting ear 17.80 × 1.69 × 1.50 452 × 43 × 38
	MG/MT models Inches (L × W × H) Millimeters (L × W × H)	17.36 × 1.69 × 1.50 441 × 43 × 38			With mounting ear 18.19 × 1.69 × 1.50 462 × 43 × 38
Net Weight	MF models	-	1430 g	-	
	MG/MT models	-	1550 g	-	

Dimming Specifications

Parameter		Min.	Typ.	Max.	Notes
Absolute Maximum Voltage on the V _{dim} (+) Pin		-20 V	-	20 V	
Source Current on V _{dim} (+) Pin		90 μA	100 μA	110 μA	V _{dim} (+) = 0 V
Dimming Output Range	NEL-400S140Mx	10%loset	-	loset	730 mA ≤ loiset ≤ 1400 mA
	NEL-400S140Mx	73 mA	-	loiset	73 mA ≤ loiset ≤ 730 mA
Recommended Dimming Input Range		0 V	-	10 V	Default 0-10V dimming mode.
Dim off Voltage		0.35 V	0.5 V	0.65 V	
Dim on Voltage		0.55 V	0.7 V	0.85 V	
Hysteresis		-	0.2 V	-	
PWM_in High Level		-	10 V	-	
PWM_in Low Level		-	0 V	-	
PWM_in Frequency Range		200 Hz	-	3 KHz	
PWM_in Duty Cycle		0%	-	100%	
PWM Dimming off		3%	5%	8%	
PWM Dimming on		5%	7%	10%	
Hysteresis		-	2%	-	

Safety & EMC Compliance

Safety Category	Standard
UL/CUL	UL 8750,CAN/GSA-C22.2 No. 250.13
ENEC & CE	EN 61347-1, EN 61347-2-13
CB	IEC 61347-1, IEC 61347-2-13
Performance	Standard
ENEC	EN IEC 62384
EMI Standards	Notes
EN IEC 55015 ⁽¹⁾	Conducted emission Test & Radiated emission Test
EN IEC 61000-3-2	Harmonic current emissions
EN 61000-3-3	Voltage fluctuations & flicker
FCC Part 15 ⁽¹⁾	ANSI C63.4 Class B
	This device complies with Part 15 of the FCC Rules. Operation is subject to the following two conditions: [1] this device may not cause harmful interference, and [2] this device must accept any interference received, including interference that may cause undesired Operation.
EMS Standards	Notes
EN 61000-4-2	Electrostatic Discharge (ESD): 8 kV air discharge, 4 kV contact discharge
EN 61000-4-3	Radio-Frequency Electromagnetic Field Susceptibility Test-RS
EN 61000-4-4	Electrical Fast Transient / Burst-EFT
EN 61000-4-5	Surge Immunity Test: AC Power Line: Differential Mode 4 kV, Common Mode 6kV ⁽²⁾
EN 61000-4-6	Conducted Radio Frequency Disturbances Test-CS
EN 61000-4-8	Power Frequency Magnetic Field Test
EN 61000-4-11	Voltage Dips
EN 61547	Electromagnetic Immunity Requirements Applies To Lighting Equipment

- Notes:** (1) This LED driver meets the EMI specifications above, but EMI performance of a luminaire that contains it depends also on the other devices connected to the driver and on the fixture itself.
- (2) To perform electric strength (hi-pot) testing, the “GDT ground disconnect” (nut and metal lock sheet) on the driver end-cap should be removed temporarily to prevent the internal gas discharge tube from conducting (as allowed by IEC 60598-1 Clause 10.2). After testing is completed, these items must be reinstalled to restore line-to-earth surge protection and secure the end cap.

Derating

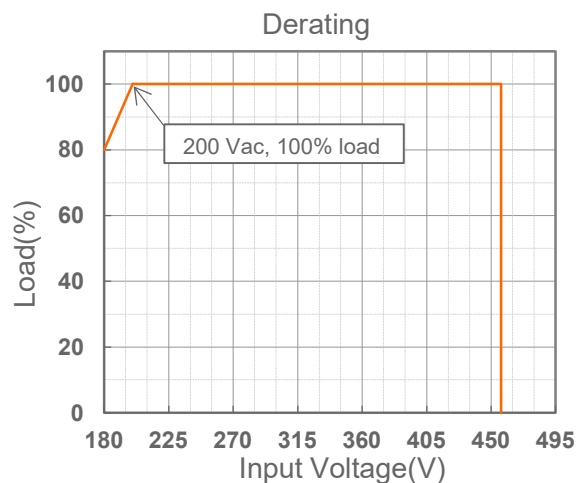

Lifetime vs. Case Temperature

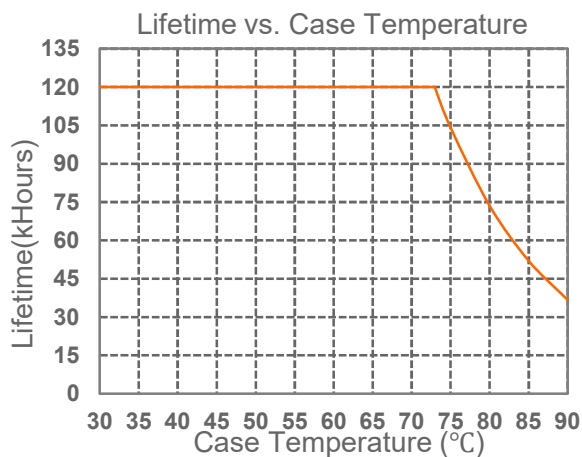

Inrush Current Waveform

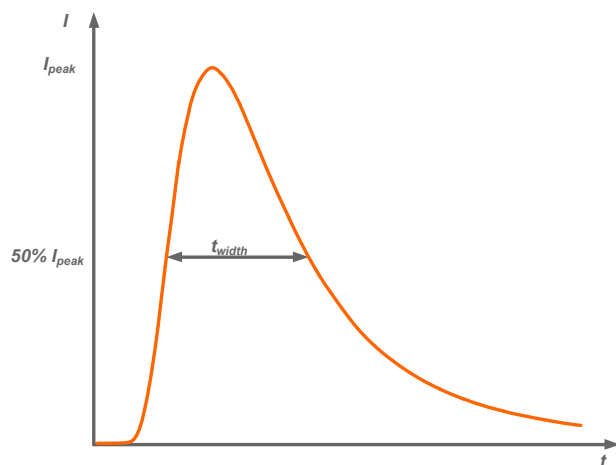

Input AC Voltage	I_{peak}	t_{width} (@ 50% I_{peak})
415V	13.1A	2.04ms

Efficiency vs. Load

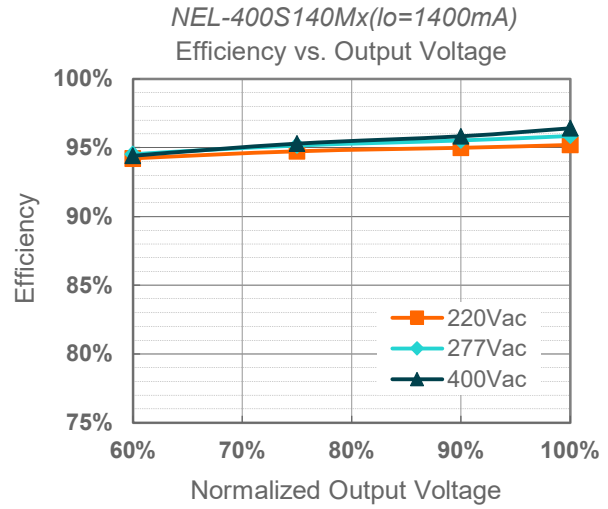
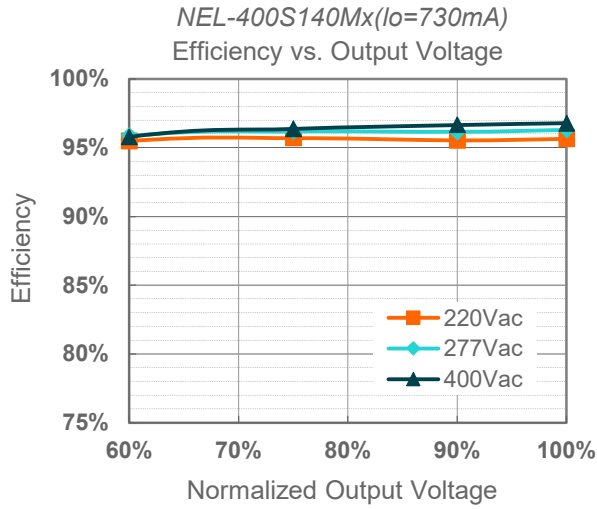

Power Factor

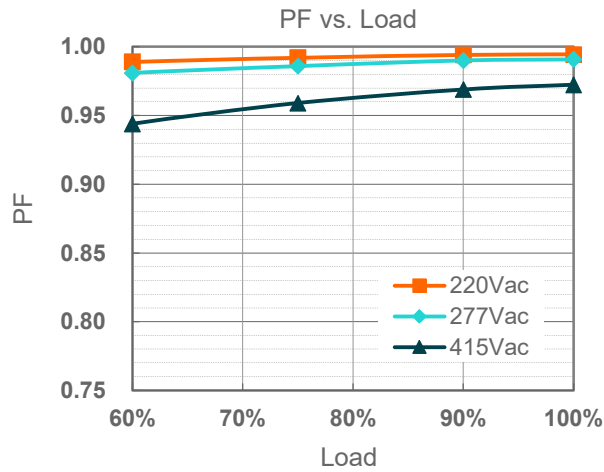

Total Harmonic Distortion

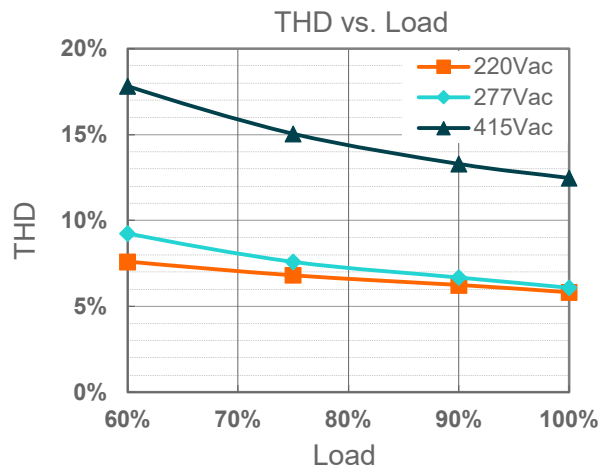

Protection Functions

Parameter	Notes
Over Voltage Protection	Limits output voltage at no load and in case the normal voltage limit fails.
Short Circuit Protection	Auto Recovery. No damage will occur when any output is short circuited. The output shall return to normal when the fault condition is removed.
Over Temperature Protection	Decreases output current, returning to normal after over temperature is removed.

Dimming

● 0-10V Dimming

The recommended implementation of the dimming control is provided below.

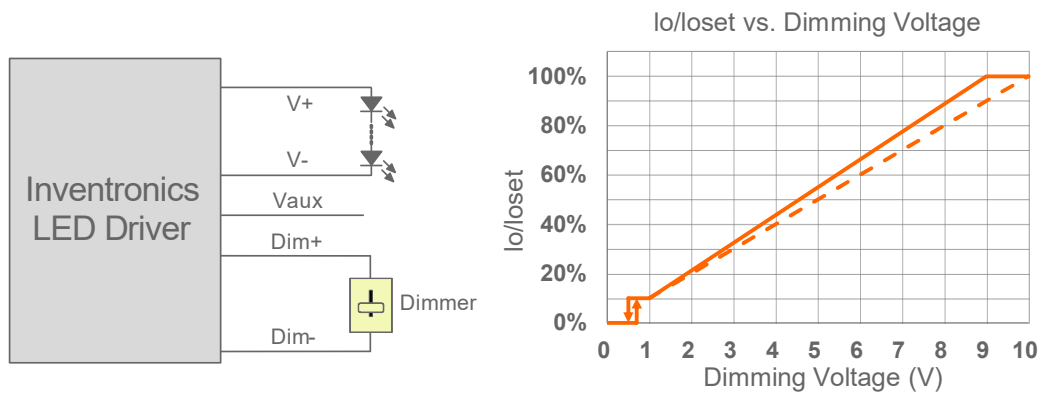

Implementation 1: Positive logic

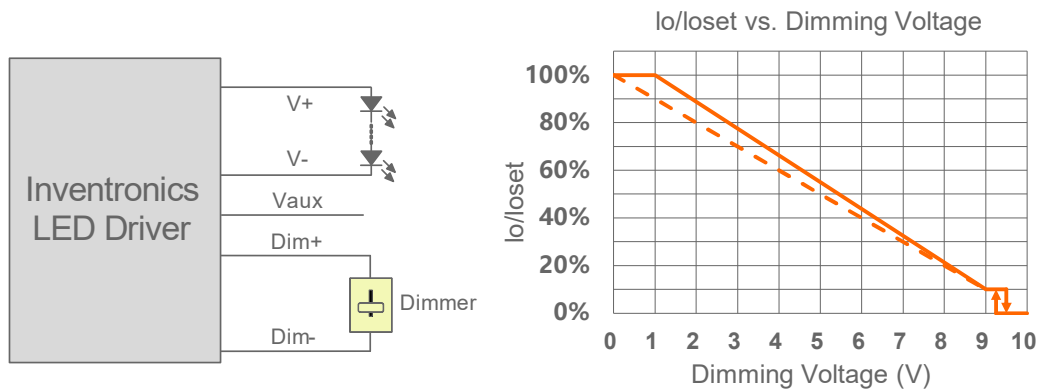

Implementation 2: Negative logic

Notes:

1. Do NOT connect Dim- to the output V- or V+, otherwise the driver will not work properly.
2. The dimmer can also be replaced by an active 0-10V voltage source signal or passive components like zener.
3. When 0-10V negative logic dimming mode and Dim+ is open, the driver will dim to off and be standby.

● 10V PWM Dimming

The recommended implementation of the dimming control is provided below.

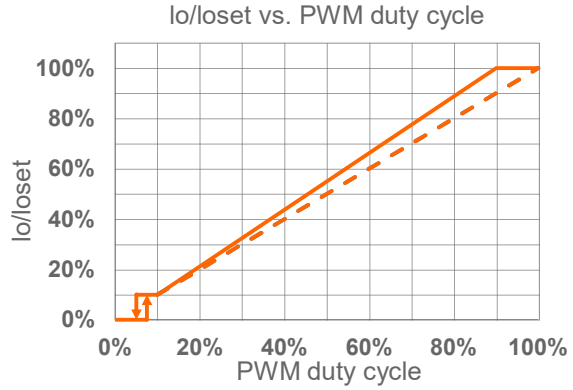
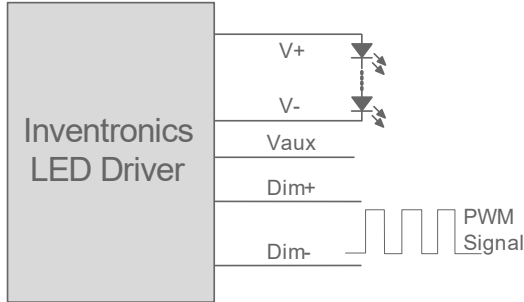

Implementation 3: Positive logic

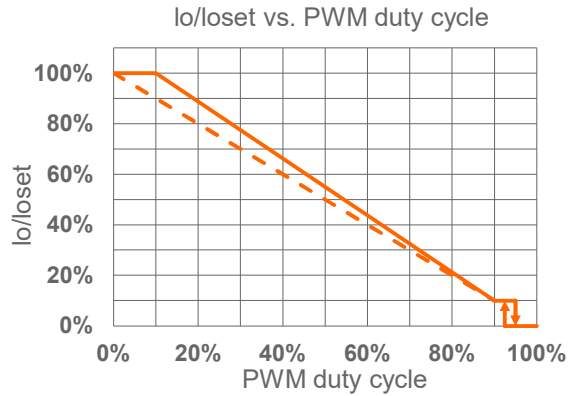
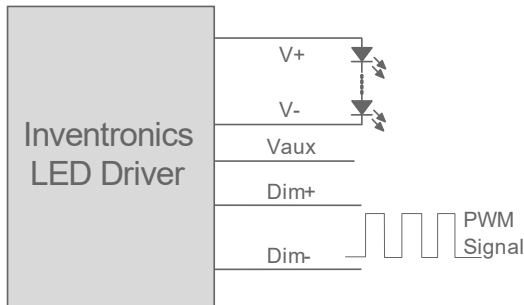

Implementation 4: Negative logic

Notes:

1. Do NOT connect Dim- to the output V- or V+, otherwise the driver will not work properly.
2. When 10V PWM negative logic dimming mode and Dim+ is open, the driver will dim to off and be standby.

● Resistor Dimming

The recommended implementation of the dimming control is provided below.

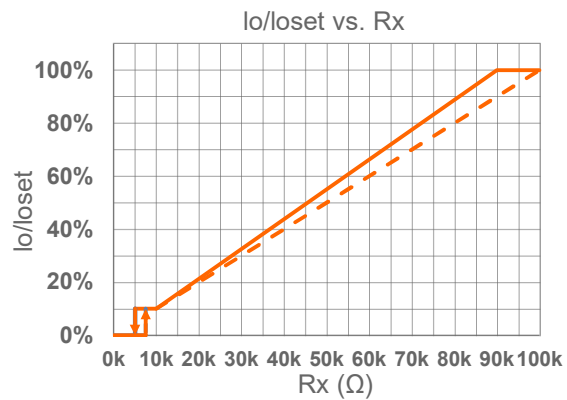
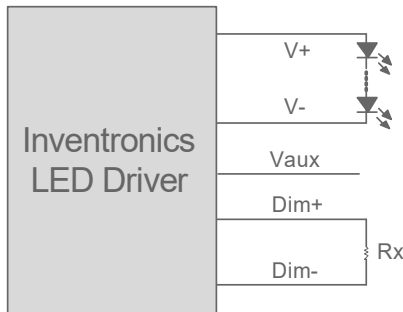

Implementation 5: Positive logic

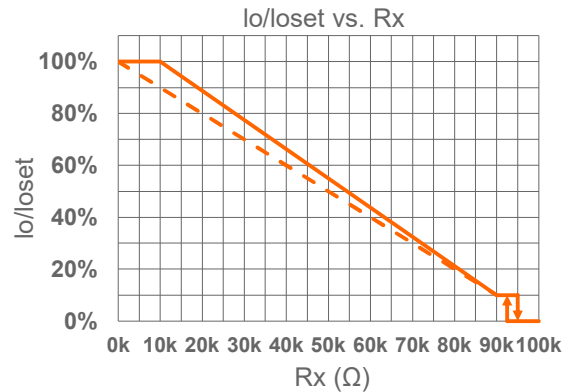
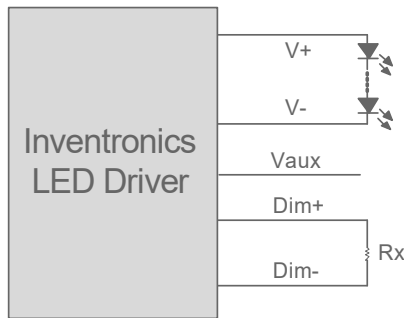

Implementation 6: Negative logic

Notes:

1. Do NOT connect Dim- to the output V- or V+, otherwise the driver will not work properly.
2. When resistor negative logic dimming mode and Dim+ is open, the driver will dim to off and be standby.

● Time Dimming

Time dimming control includes 3 kinds of modes, they are Self Adapting-Midnight, Self Adapting-Percentage and Traditional Timer.

- **Self Adapting-Midnight:** Automatically adjusts the dimming curve based on the on-time of past two days (if difference <15 minutes), assuming that the center point of the dimming curve is midnight local time.
- **Self Adapting-Percentage:** Automatically adjusts the on-time of each step by a constant percentage = (actual on-time for the past 2 days if difference <15 min) / (programmed on-time from the dimming curve).
- **Traditional Timer:** Follows the programmed timing curve after power on with no changes.

● Output Lumen Compensation

Output Lumen Compensation (OLC) may be used to maintain constant light output over the life of the LEDs by driving them at a reduced current when new, then gradually increasing the drive current over time to counteract LED lumen degradation.

● Maximum Dimming Level with 9V or 10V Selectable

The maximum dimming level can be set as corresponding dimming voltage is 9V or 10V by Inventronics Multi Programmer, 9V is default.

● Fade Time Adjustable

Soft-start time and dimming slope can be adjusted by Inventronics Multi Programmer to get customized fade time experience, disable mode is default.

● End Of Life

End-of-Life (EOL) is providing a visual notification to a user that the LED module has reached the end of manufacturer-specified life and that the replacement is recommended. Once active, an indication is given at each power-up of the driver, which the driver indicates this through a lower light output during the first 1 minute before normal operation is continued.

Programming Connection Diagram

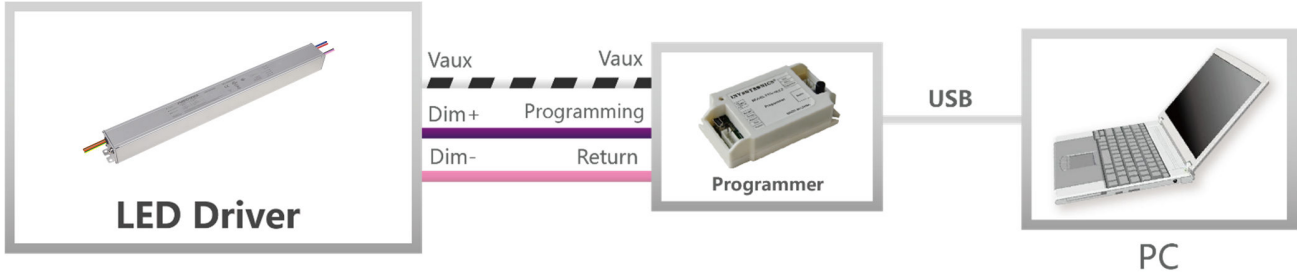

Note: The driver does not need to be powered on during the programming process.

- Please refer to [PRG-MUL2](#) (Programmer) datasheet for details.

Mechanical Outline

NEL-400SxxxMF

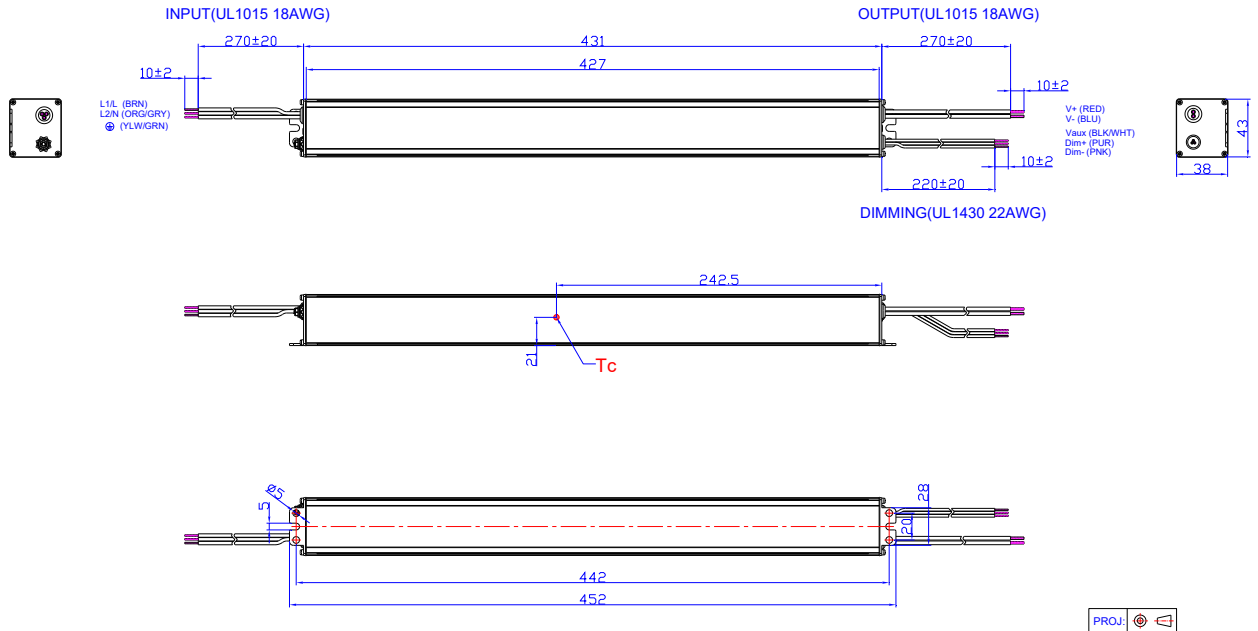

Unspecified tolerance: ±1

NEL-400SxxxMG

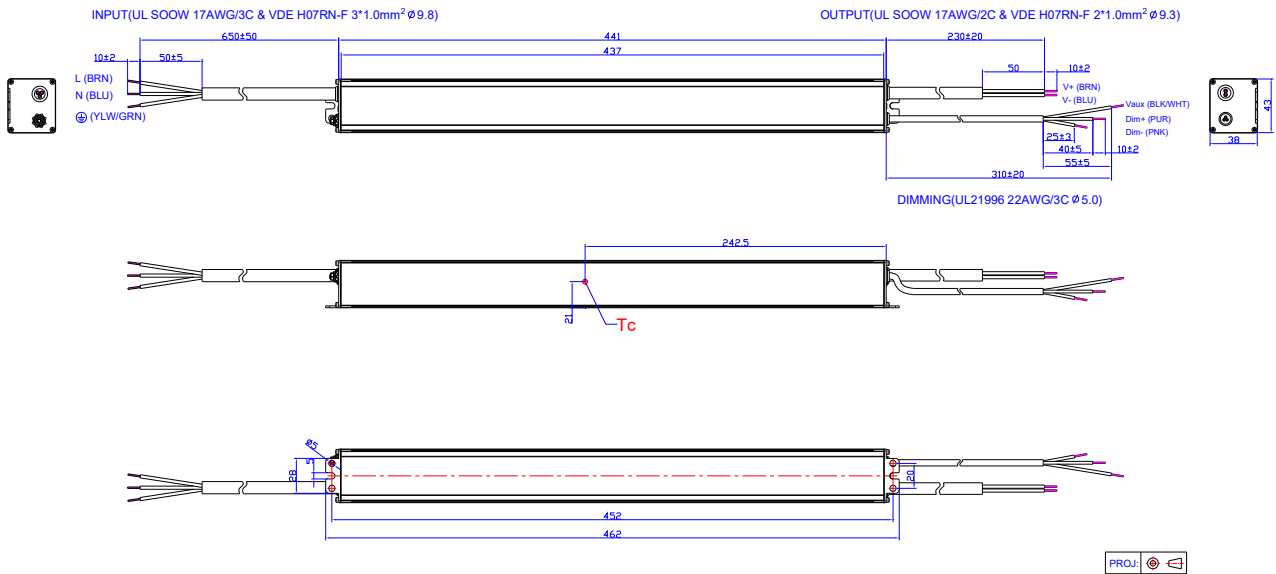

Unspecified tolerance: ±1

NEL-400SxxxMT

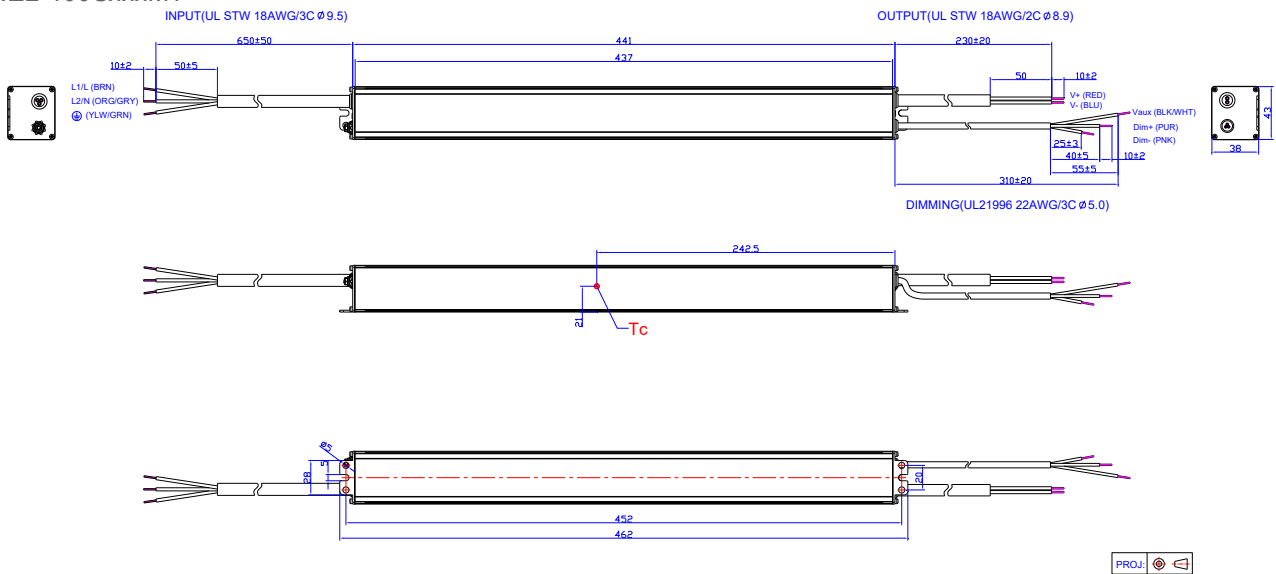

Unspecified tolerance: ±1

RoHS Compliance

Our products comply with reference to RoHS Directive (EU) 2015/863 amending 2011/65/EU, calling for the elimination of lead and other hazardous substances from electronic products.

Revision History

Change Date	Rev.	Description of Change		
		Item	From	To
2023-07-26	A	Datasheet Release	/	/
2023-11-13	B	Format	/	Updated
		Models	/	Updated
		Inrush Current Waveform	/	Updated
2026-03-20	C	Product Photograph	/	Updated
		UKCA logo	/	Deleted
		Safety &EMC Compliance	/	Updated