

Features

- Ultra High Efficiency (Up to 95%)
- Full Power at Wide Output Current Range (Constant Power)
- Thermal Sensing and Protection for LED Module
- 0-10V/PWM/Timer Dimmable (3 Timer Modes, Isolated design)
- Dim-to-Off with Standby Power ≤ 0.5 W
- Output Lumen Compensation
- Input Surge Protection: DM 6kV, CM 10kV
- All-Around Protection: OVP, SCP, OTP
- IP67 and UL Dry / Damp / Wet Location
- SELV Output
- TYPE HL, for use in a Class I, Division 2 Hazardous (Classified) location
- 7 Years Warranty



Description

The EUD-480SxxxDT series is a 480W, constant-current, programmable LED driver that operates from 90-305 Vac input with excellent power factor. Created for many lighting applications including high bay, high mast, aquaculture and sport, it provides a dim-to-off mode with low standby power. The high efficiency of these drivers and compact metal case enables them to run cooler, significantly improving reliability and extending product life. To ensure trouble-free operation, protection is provided against input surge, output over voltage, short circuit, and over temperature.

Models

Adjustable Output Current Range	Full-Power Current Range(1)	Default Output Current	Input Voltage Range(2)	Output Voltage Range	Max. Output Power	Typical Efficiency (3)	Typical Power Factor		Model Number
							120Vac	220Vac	
0.105-1.40A	1.05-1.40A	1.4 A	90~305Vac/ 127~300Vdc	171 ~ 457Vdc	480W	95.0%	0.99	0.96	EUD-480S140DT
0.210-2.80A	2.10-2.80A	2.8 A	90~305Vac/ 127~300Vdc	86 ~ 228Vdc	480 W	94.0%	0.99	0.96	EUD-480S280DT
0.315-4.20A	3.15-4.20A	4.2 A	90~305Vac/ 127~300Vdc	57 ~ 152Vdc	480 W	94.5%	0.99	0.96	EUD-480S420DT
0.435-5.60A	4.35-5.60A	5.6 A	90~305Vac/ 127~300Vdc	43 ~ 110Vdc	480 W	94.0%	0.99	0.96	EUD-480S560DT ⁽⁴⁾
0.750-10.0A	7.50-10.0A	10.0 A	90~305Vac/ 127~300Vdc	24 ~ 64Vdc	480 W	94.0%	0.99	0.96	EUD-480S10ADT ⁽⁴⁾

Notes: (1) Output current range with constant power at 480W

(2) UL, FCC certified input voltage range: 100-277Vac or 127-300Vdc; otherwise: 100-240Vac or 127-250Vdc.

(3) Measured at 100% load and 220Vac input (see below "General Specifications" for details).

(4) SELV Output

I-V Operating Area

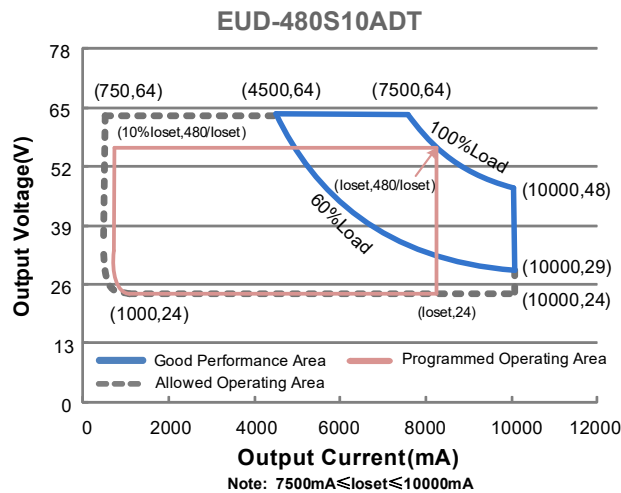
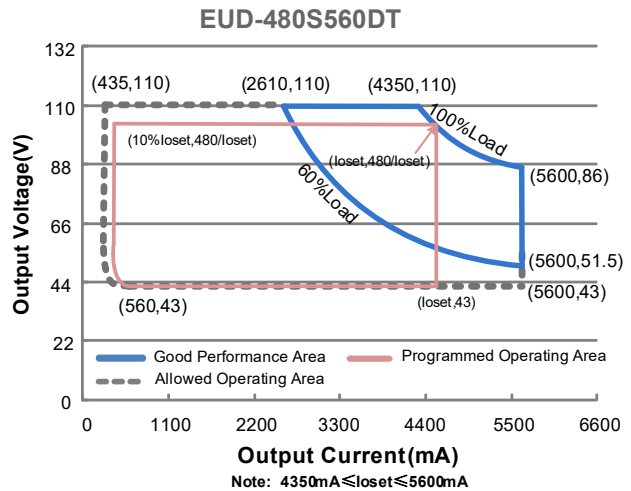
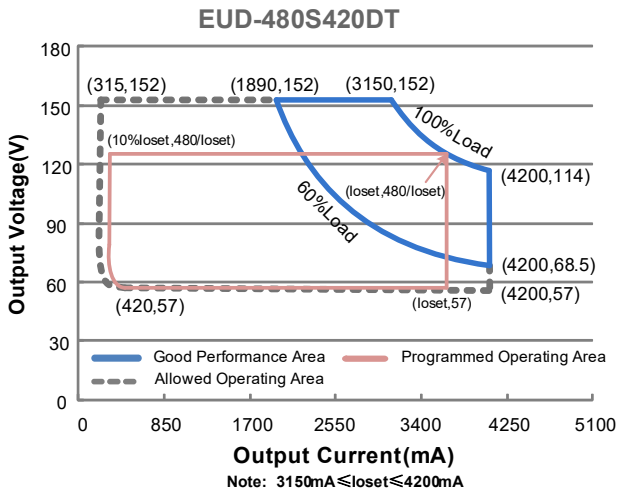
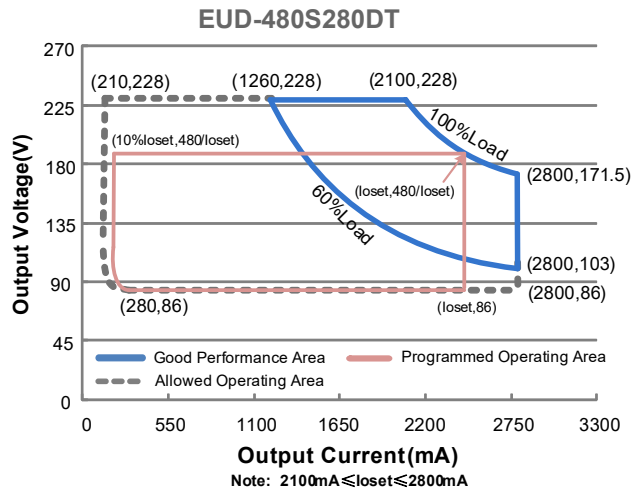
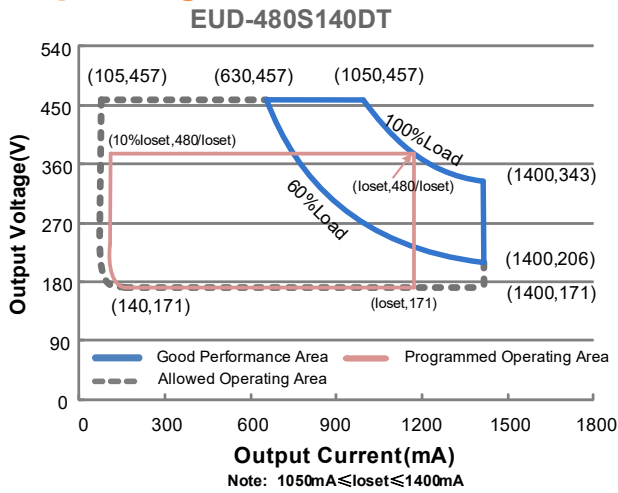

Input Specifications

Parameter	Min.	Typ.	Max.	Notes
Input AC Voltage	90 Vac	-	305 Vac	
Input DC Voltage	127 Vdc	-	300 Vdc	
Input Frequency	47 Hz	-	63 Hz	
Leakage Current	-	-	0.75 MIU	UL 8750; 277Vac/ 60Hz
	-	-	0.70 mA	IEC 60598-1; 240Vac/ 60Hz
Input AC Current	-	-	4.95 A	Measured at 100% load and 120 Vac input.
	-	-	2.65 A	Measured at 100% load and 220 Vac input.
Inrush Current(I ² t)	-	-	2.80A ² s	At 220Vac input, 25°C cold start, duration=5.56 ms, 10%I _{pk} -10%I _{pk} . See Inrush Current Waveform for the details.
PF	0.90	-	-	At 100-277Vac, 50-60Hz, 60%-100% Load (288-480W)
THD	-	-	20%	
THD	-	-	10%	At 220-240Vac, 50-60Hz, 75%-100% Load (360-480W)

Output Specifications

Parameter	Min.	Typ.	Max.	Notes
Output Current Tolerance	-5%loset	-	5%loset	At 100% load condition
Output Current Setting(I _o set) Range				
EUD-480S140DT	105 mA	-	1400 mA	
EUD-480S280DT	210 mA	-	2800 mA	
EUD-480S420DT	315 mA	-	4200 mA	
EUD-480S560DT	435 mA	-	5600 mA	
EUD-480S10ADT	750 mA	-	10000 mA	
Output Current Setting Range with Constant Power				
EUD-480S140DT	1050 mA	-	1400 mA	
EUD-480S280DT	2100 mA	-	2800 mA	
EUD-480S420DT	3150 mA	-	4200 mA	
EUD-480S560DT	4350 mA	-	5600 mA	
EUD-480S10ADT	7500 mA	-	10000 mA	
Total Output Current Ripple (pk-pk)	-	5%lomax	10%lomax	At 100% load condition, 20 MHz BW
Output Current Ripple at < 200 Hz (pk-pk)	-	2%lomax	-	At 100% load condition. Only this component of ripple is associated with visible flicker.
Startup Overshoot Current	-	-	10%lomax	At 100% load condition
No Load Output Voltage				
EUD-480S140DT	-	-	500Vdc	
EUD-480S280DT	-	-	280Vdc	
EUD-480S420DT	-	-	190Vdc	
EUD-480S560DT	-	-	120Vdc	
EUD-480S10ADT	-	-	80Vdc	
Line Regulation	-	-	±0.5%	Measured at 100% load

Output Specifications (Continued)

Parameter	Min.	Typ.	Max.	Notes
Load Regulation	-	-	± 1.5%	
Turn-on Delay Time	-	-	1.0 s	Measured at 120Vac input, 60%-100% Load
	-	-	0.5 s	Measured at 220Vac input, 60%-100% Load
Temperature Coefficient of I _o set	-	0.03%/°C		Case temperature = 0°C ~T _c max
12V Auxiliary Output Voltage	10.8 V	12 V	13.2 V	
12V Auxiliary Output Source Current	0 mA	-	200 mA	Return terminal is "Dim-"

General Specifications

Parameter	Min.	Typ.	Max.	Notes
Efficiency at 120 Vac input:				Measured at 100% load and steady-state temperature in 25°C ambient; (Efficiency will be about 2.0% lower if measured immediately after startup.)
EUD-480S140DT				
I _o = 1050 mA	90.5%	92.5%	-	
I _o = 1400 mA	89.5%	91.5%	-	
EUD-480S280DT				
I _o = 2100 mA	90.0%	92.0%	-	
I _o = 2800 mA	88.5%	90.5%	-	
EUD-480S420DT				
I _o = 3150 mA	90.5%	92.5%	-	
I _o = 4200 mA	89.0%	91.0%	-	
EUD-480S560DT				
I _o = 4350 mA	90.0%	92.0%	-	
I _o = 5600 mA	89.0%	91.0%	-	
EUD-480S10ADT				
I _o = 7500 mA	90.0%	92.0%	-	
I _o = 10000 mA	89.0%	91.0%	-	
Efficiency at 220 Vac input:				Measured at 100% load and steady-state temperature in 25°C ambient; (Efficiency will be about 2.0% lower if measured immediately after startup.)
EUD-480S140DT				
I _o = 1050 mA	93.0%	95.0%	-	
I _o = 1400 mA	92.0%	94.0%	-	
EUD-480S280DT				
I _o = 2100 mA	92.0%	94.0%	-	
I _o = 2800 mA	91.0%	93.0%	-	
EUD-480S420DT				
I _o = 3150 mA	92.5%	94.5%	-	
I _o = 4200 mA	91.0%	93.0%	-	
EUD-480S560DT				
I _o = 4350 mA	92.0%	94.0%	-	
I _o = 5600 mA	91.0%	93.0%	-	
EUD-480S10ADT				
I _o = 7500 mA	92.0%	94.0%	-	
I _o = 10000 mA	90.5%	92.5%	-	

General Specifications (Continued)

Parameter	Min.	Typ.	Max.	Notes
Efficiency at 277 Vac input: EUD-480S140DT I _o = 1050 mA I _o = 1400 mA EUD-480S280DT I _o = 2100 mA I _o = 2800 mA EUD-480S420DT I _o = 3150 mA I _o = 4200 mA EUD-480S560DT I _o = 4350 mA I _o = 5600 mA EUD-480S10ADT I _o = 7500 mA I _o = 10000 mA	93.5% 92.5% 92.5% 91.0% 92.5% 91.0% 92.5% 91.5% 92.0% 91.0%	95.5% 94.5% 94.5% 93.0% 94.5% 93.0% 94.5% 93.5% 94.0% 93.0%	- - - - - - - - - -	Measured at 100% load and steady-state temperature in 25°C ambient; (Efficiency will be about 2.0% lower if measured immediately after startup.)
Standby power	-	-	0.5 W	Measured at 230Vac/50Hz; Dimming off
MTBF	-	216,000 Hours	-	Measured at 220Vac input, 80%Load and 25°C ambient temperature (MIL-HDBK-217F)
Lifetime	-	91,000 Hours	-	Measured at 220Vac input, 80%Load and 70°C case temperature; See lifetime vs. T _c curve for the details
Operating Case Temperature for Safety T _{c_s}	-40°C	-	+85°C	
Operating Case Temperature for Warranty T _{c_w}	-40°C	-	+75°C	Case temperature for 7 years warranty. <i>Please see Inventronics Warranty Statement for complete details.</i>
Storage Temperature	-40°C	-	+85°C	Humidity: 5%RH to 100%RH
Dimensions Inches (L × W × H) Millimeters (L × W × H)	9.26 × 4.93 × 1.72 235 × 125 × 43.5			With mounting ear 10.32 × 4.93 × 1.72 262 × 125 × 43.5
Net Weight	-	2650 g	-	

Dimming Specifications

Parameter	Min.	Typ.	Max.	Notes	
Absolute Maximum Voltage on the V _{dim} (+) Pin	-20 V	-	20 V		
Source Current on V _{dim} (+)Pin	200 uA	300 uA	450 uA	V _{dim} (+) = 0 V	
Dimming Output Range	EUD-480S140DT EUD-480S280DT EUD-480S420DT EUD-480S560DT EUD-480S10ADT	10%I _o set	-	I _o set	1050mA ≤ I _o set ≤ 1400mA 2100mA ≤ I _o set ≤ 2800mA 3150mA ≤ I _o set ≤ 4200mA 4350mA ≤ I _o set ≤ 5600mA 7500mA ≤ I _o set ≤ 10000mA
	EUD-480S140DT EUD-480S280DT EUD-480S420DT EUD-480S560DT EUD-480S10ADT	105 mA 210 mA 315 mA 435 mA 750 mA	-	I _o set	105mA ≤ I _o set < 1050mA 210mA ≤ I _o set < 2100mA 315mA ≤ I _o set < 3150mA 435mA ≤ I _o set < 4350mA 750mA ≤ I _o set < 7500mA

Dimming Specifications (Continued)

Parameter	Min.	Typ.	Max.	Notes
Recommended Dimming Input Range	0 V	-	10 V	Default 0-10V dimming mode.
Dim off Voltage	0.35 V	0.5 V	0.65 V	
Dim on Voltage	0.55 V	0.7 V	0.85 V	
Hysteresis	-	0.2 V	-	
PWM_in High Level	3 V	-	10 V	Dimming mode set to PWM in Inventronics Programing Software.
PWM_in Low Level	-0.3 V	-	0.6 V	
PWM_in Frequency Range	200 Hz	-	3 KHz	
PWM_in Duty Cycle	1%	-	99%	
PWM Dimming off (Positive Logic)	3%	5%	8%	
PWM Dimming on (Positive Logic)	5%	7%	10%	
PWM Dimming off (Negative Logic)	92%	95%	97%	
PWM Dimming on (Negative Logic)	90%	93%	95%	
Hysteresis	-	2%	-	

Safety & EMC Compliance

Safety Category	Standard
UL/CUL	UL 8750,CAN/CSA-C22.2 No. 250.13-12
CE	EN 61347-1, EN 61347-2-13
EMI Standards	Notes
EN IEC 55015/KS C 9815 ⁽¹⁾	Conducted emission Test &Radiated emission Test
EN IEC 61000-3-2	Harmonic current emissions
EN 61000-3-3	Voltage fluctuations & flicker
FCC Part 15 ⁽¹⁾	ANSI C63.4 Class B
	This device complies with Part 15 of the FCC Rules. Operation is subject to the following two conditions: [1] this device may not cause harmful interference, and [2] this device must accept any interference received, including interference that may cause undesired Operation.
EMS Standards	Notes
EN 61000-4-2	Electrostatic Discharge (ESD): 8 kV air discharge, 4 kV contact discharge
EN 61000-4-3	Radio-Frequency Electromagnetic Field Susceptibility Test-RS
EN 61000-4-4	Electrical Fast Transient / Burst-EFT
EN 61000-4-5	Surge Immunity Test: AC Power Line: Differential Mode 6 kV, Common Mode 10 kV ⁽²⁾

Safety & EMC Compliance (Continued)

EMS Standards	Notes
EN 61000-4-6	Conducted Radio Frequency Disturbances Test-CS
EN 61000-4-8	Power Frequency Magnetic Field Test
EN 61000-4-11	Voltage Dips
EN 61547/KS C 9547	Electromagnetic Immunity Requirements Applies To Lighting Equipment

Note: (1) This LED driver meets the EMI specifications above, but EMI performance of a luminaire that contains it depends also on the other devices connected to the driver and on the fixture itself.

(2) To perform electric strength (hi-pot) testing, the “GDT ground disconnect” (nut and metal lock sheet) on the driver end-cap should be removed temporarily to prevent the internal gas discharge tube from conducting (as allowed by IEC 60598-1 Clause 10.2). After testing is completed, these items must be reinstalled to restore line-to-earth surge protection and secure the end cap.

Derating

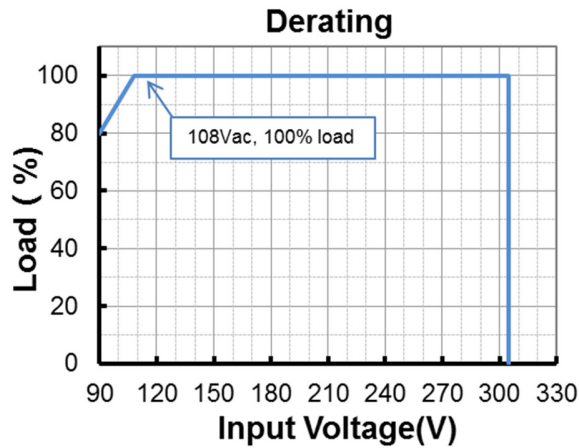

Lifetime vs. Case Temperature

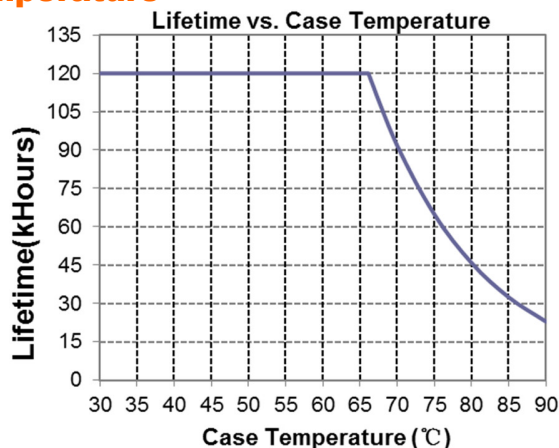

Inrush Current Waveform

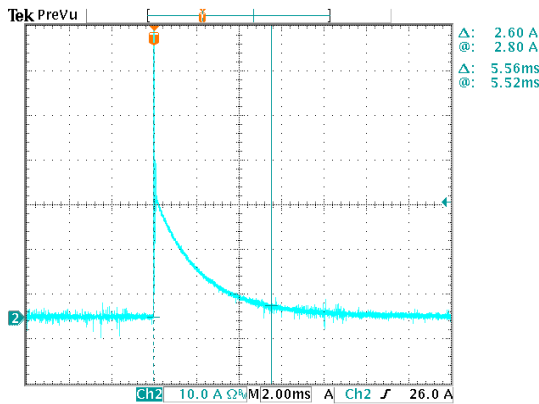

Efficiency vs. Load

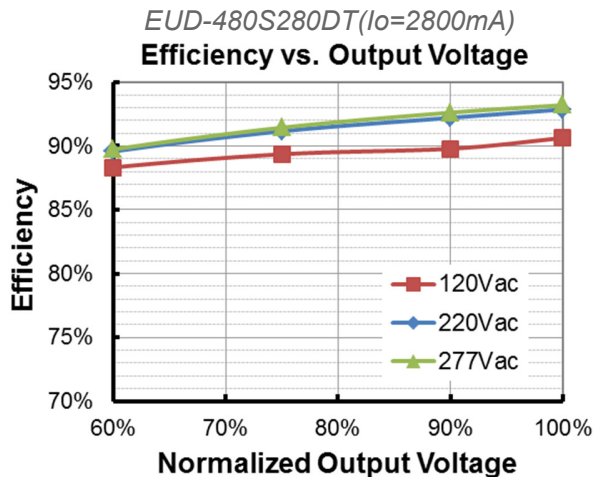
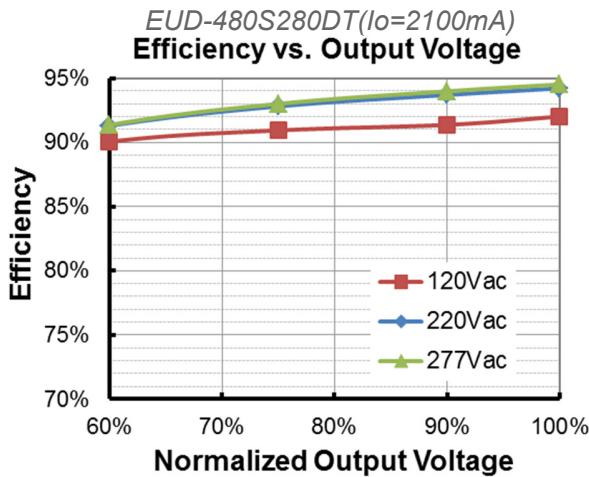
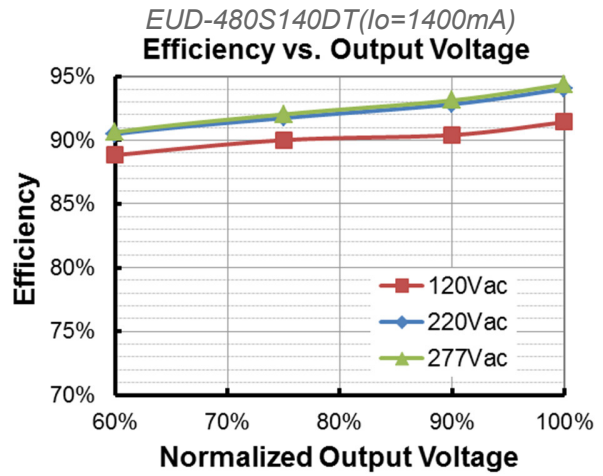
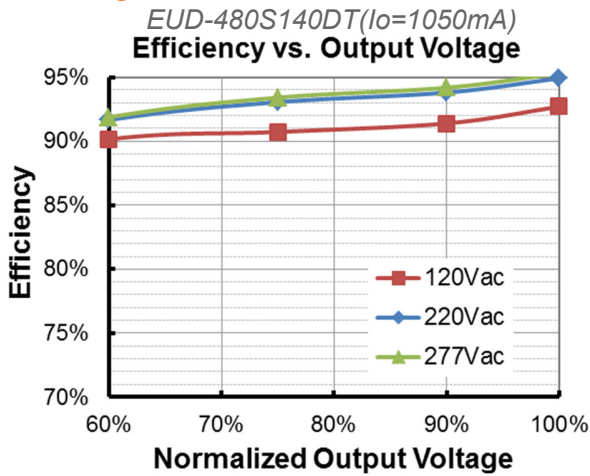

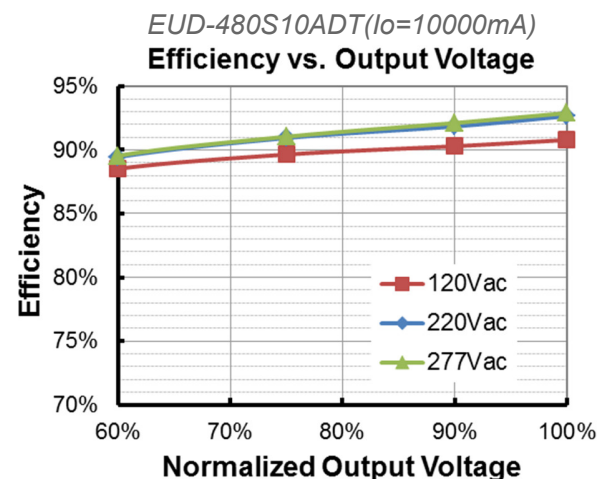
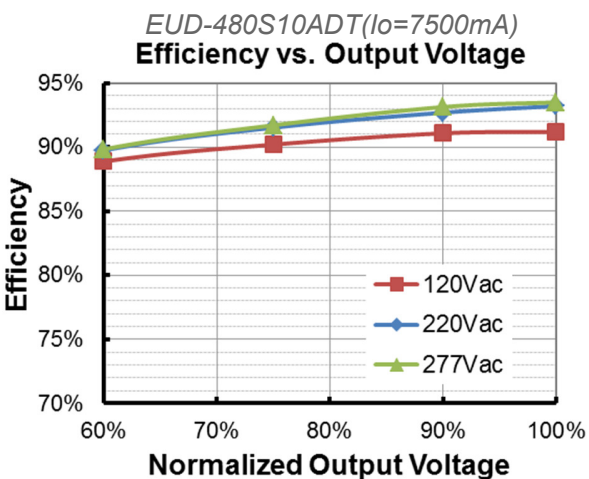
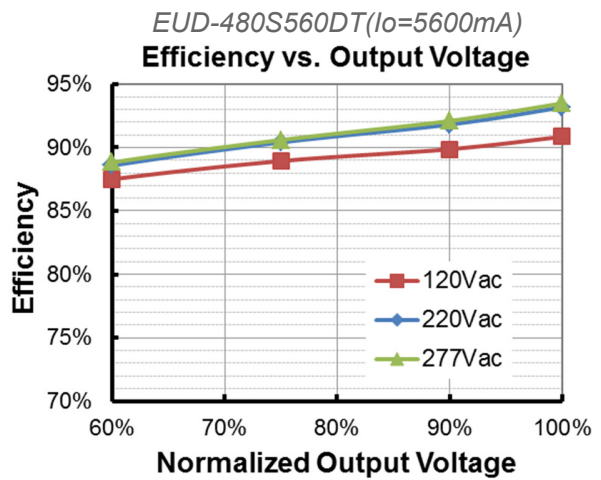
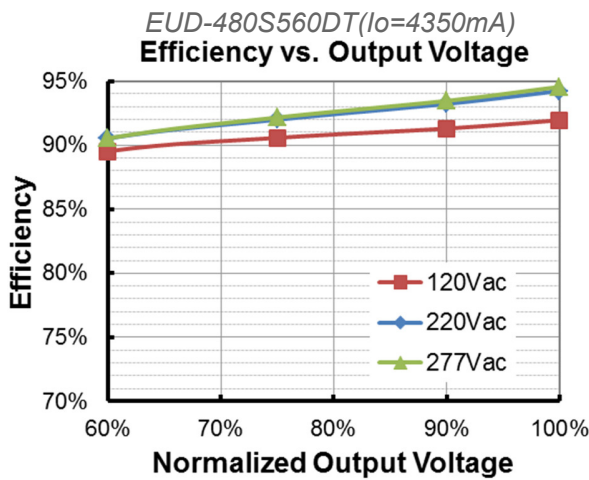
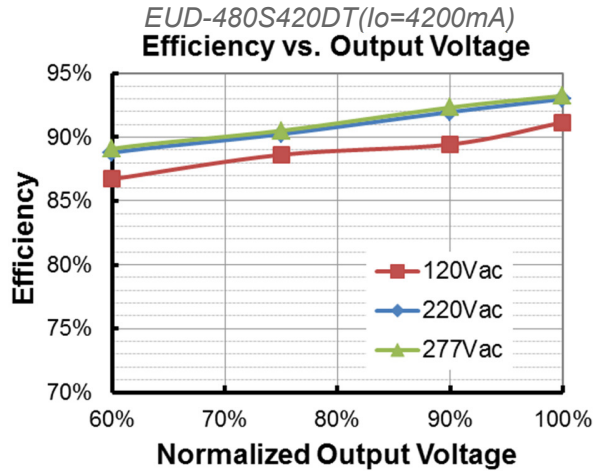
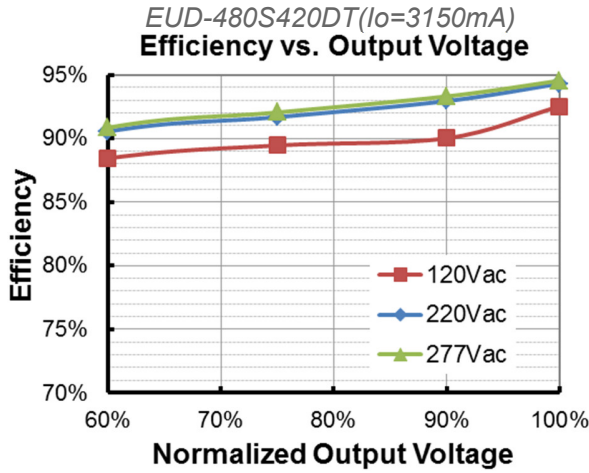

Power Factor

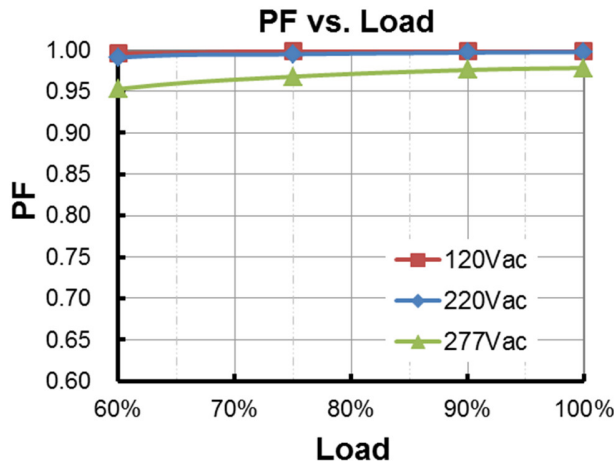

Total Harmonic Distortion

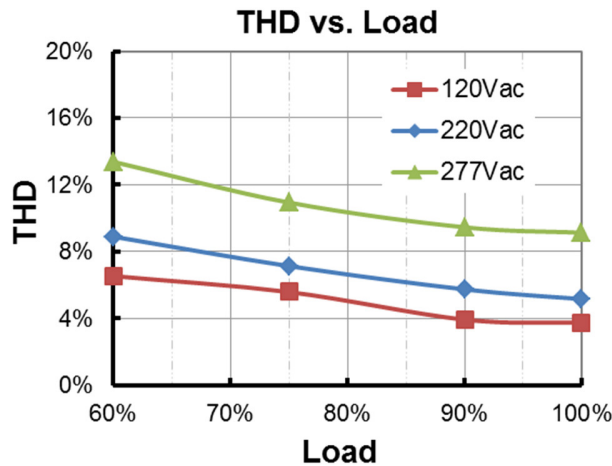

Protection Functions

Parameter		Min.	Typ.	Max.	Notes
External Thermal Protection NTC	R1	-	7.81 kOhm	-	When R_NTC falls below R1, External Thermal Protection is triggered, reducing output current until R2 is reached.
	R2	-	4.16 kOhm	-	When R_NTC is less than R2, output current is reduced to the programmed "Protection Current Floor."
	Protection Current Floor	10%loset	60%loset	100%loset	10%loset > lomin (default setting is 60%)
lomin		60%loset	100%loset	10%loset ≤ lomin (default setting is 60%)	
Over Temperature Protection		Decreases output current, returning to normal after over temperature is removed.			
Short Circuit Protection		Auto Recovery. No damage will occur when any output is short circuited. The output shall return to normal when the fault condition is removed.			
Over Voltage Protection		Limits output voltage at no load and in case the normal voltage limit fails.			

Dimming

● 0-10V Dimming

The recommended implementation of the dimming control is provided below.

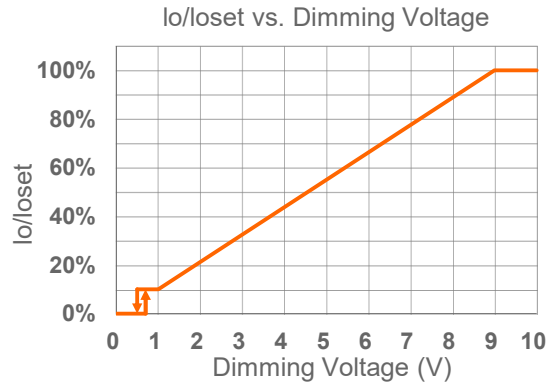
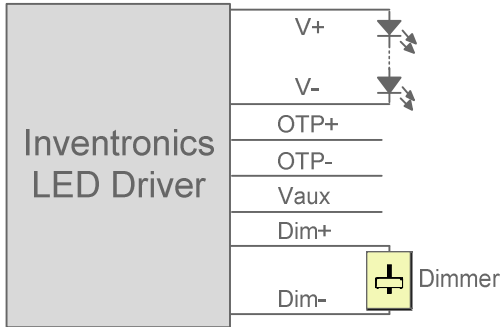

Implementation 1: DC Input

Notes:

1. Do NOT connect Dim- to the output V- or V+, otherwise the driver will not work properly.
2. The dimmer can also be replaced by an active 0-10V voltage source signal or passive components like zener.

● PWM Dimming

The recommended implementation of the dimming control is provided below.

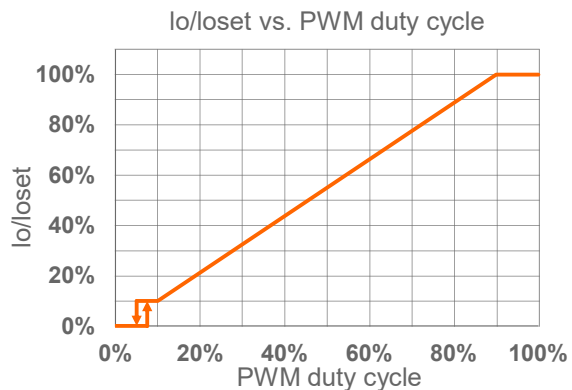
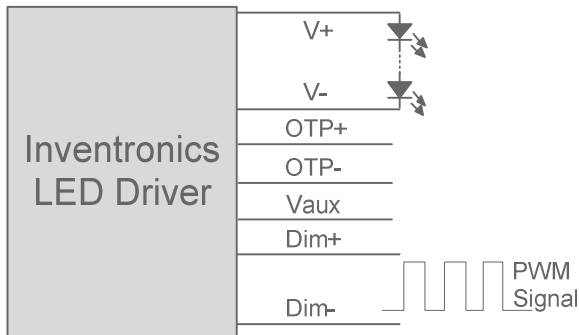

Implementation 2: Positive logic

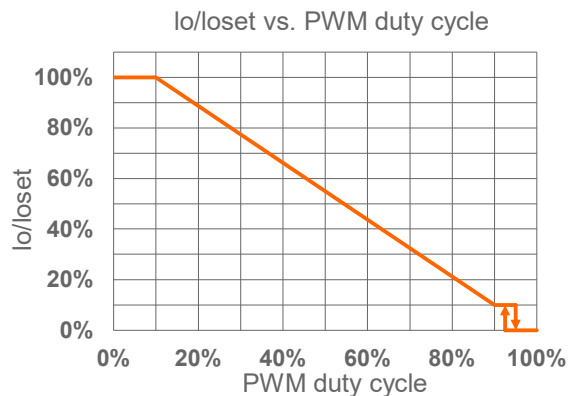
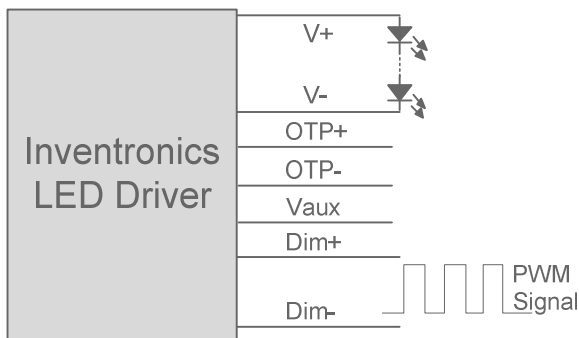

Implementation 3: Negative logic

Notes:

1. Do NOT connect Dim- to the output V- or V+, otherwise the driver will not work properly.
2. When PWM negative logic dimming mode and Dim+ is open, the driver will dim to off and be standby.

● **Time Dimming**

Time dimming control includes 3 kinds of modes, they are Self Adapting-Midnight, Self Adapting-Percentage and Traditional Timer.

- **Self Adapting-Midnight:** Automatically adjusts the dimming curve based on the on-time of past two days (if difference <15 minutes), assuming that the center point of the dimming curve is midnight local time.
- **Self Adapting-Percentage:** Automatically adjusts the on-time of each step by a constant percentage = (actual on-time for the past 2 days if difference <15 min) / (programmed on-time from the dimming curve).
- **Traditional Timer:** Follows the programmed timing curve after power on with no changes.

● **Output Lumen Compensation**

Output Lumen Compensation (OLC) may be used to maintain constant light output over the life of the LEDs by driving them at a reduced current when new, then gradually increasing the drive current over time to counteract LED lumen degradation.

Programming Connection Diagram

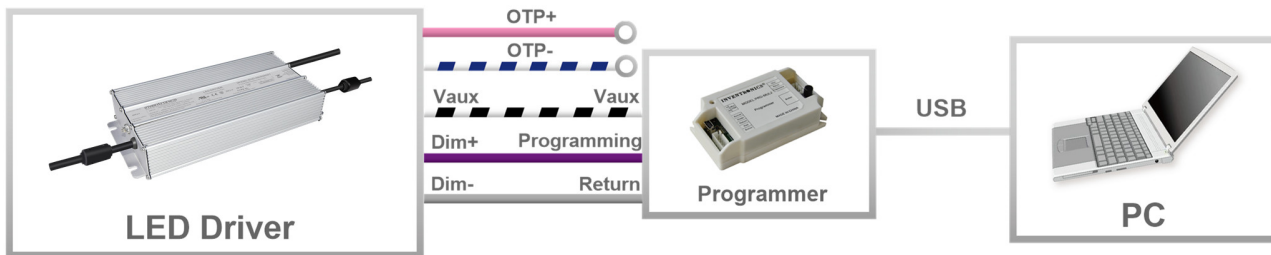

Note: The driver does not need to be powered on during the programming process.

- Please refer to [PRG-MUL2 \(Programmer\) datasheet](#) for details.

Mechanical Outline

EUD-480S140DT

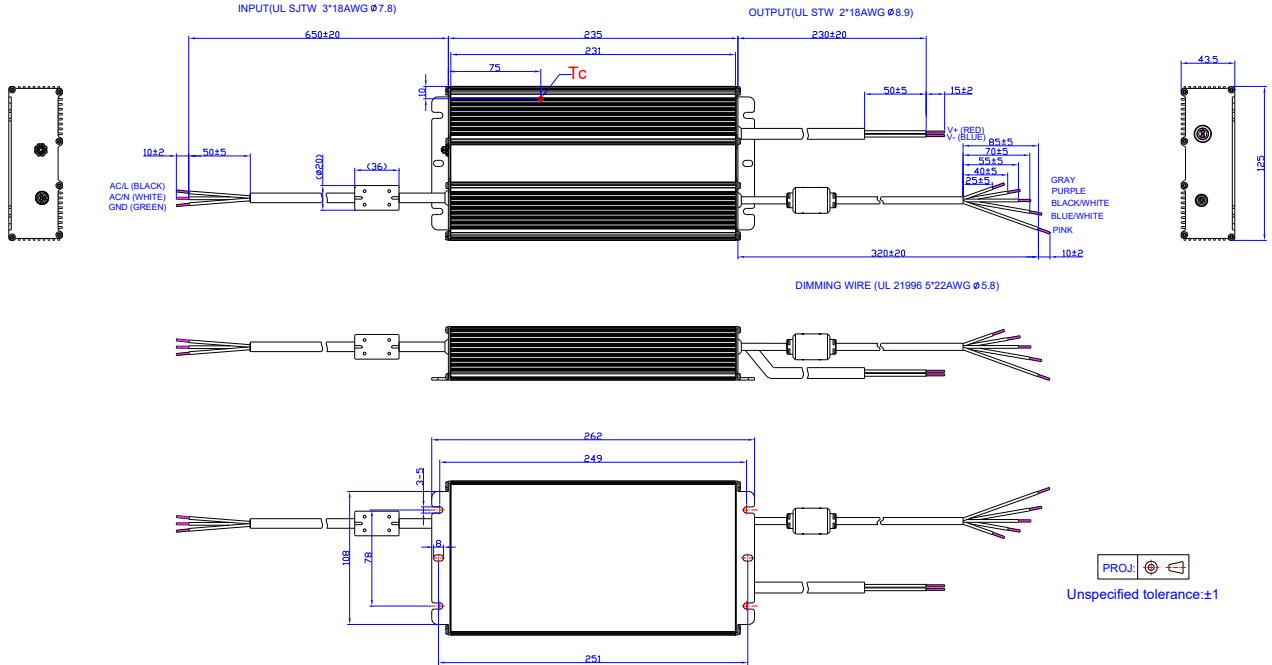

Others Models

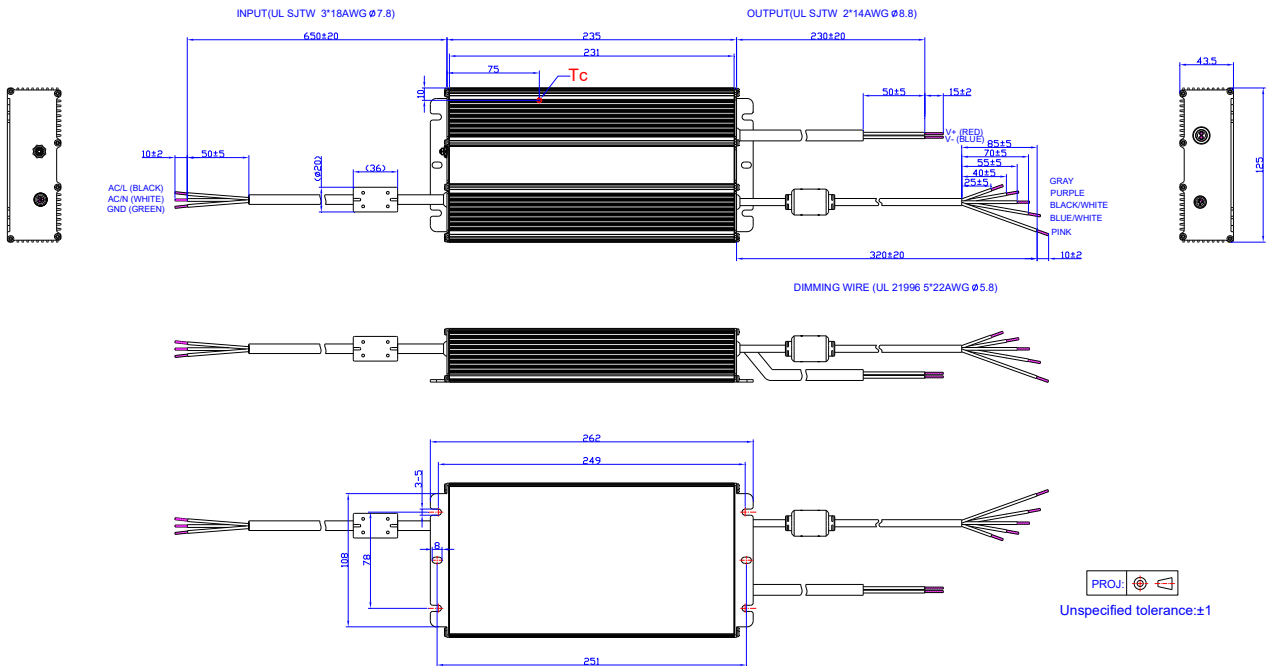

RoHS Compliance

Our products comply with reference to RoHS Directive (EU) 2015/863 amending 2011/65/EU, calling for the elimination of lead and other hazardous substances from electronic products.

Revision History

Change Date	Rev.	Description of Change		
		Item	From	To
2018-08-10	A	Datasheets Release	/	/
2026-03-11	B	Format	/	Updated
		Product Photograph	/	Updated
		KCC logo	/	Added
		Safety &EMC Compliance	/	Updated
		RoHS Compliance	/	Updated