

Features

- Full Power at Wide Output Current Range (Constant Power)
- Adjustable Output Current (AOC) with NFC
- DALI-2 and D4i Certified
- 3-Timer-Modes Dimmable
- Dim-to-Off with Low Standby Power
- Always-on Auxiliary Power:
24Vdc, 125mA, 3W (Transient Peak Power up to 10W)
- Integrated 16Vdc Bus Power Supply based on DALI-2
- Integrated Power Monitoring with High Accuracy up to $\pm 1\%$
- Output Lumen Compensation
- End-of-Life Indicator
- Thermal Sensing and Protection for LED Module
- Input Surge Protection: DM 6kV, CM 10kV
- All-Around Protection: IUVP, IOVP, OVP, SCP, OTP
- IP66/IP67 and UL Dry/Damp/Wet Location
- TYPE HL, for Use in a Class I, Division 2 Hazardous (Classified) Location
- 5 Year Warranty

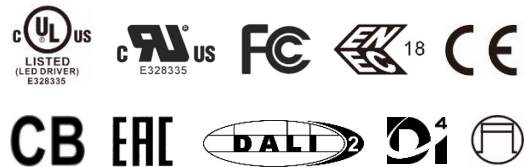
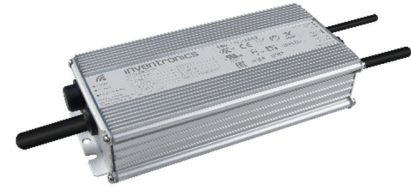

Description

The ESM-150SxxxBx series is a 150W, constant-current, NFC programmable and IP66/IP67 rated LED driver that operates from 249-528Vac input with excellent power factor. Created for intra-luminaire solutions and health monitoring applications, this family provides integrated AC power monitoring with an auxiliary voltage and dim-to-off functionality for powering low voltage, wireless controls. The dimming control supports two-way communication via DALI-2 and complies with D4i. The high efficiency of these drivers and compact metal case enables them to run cooler, significantly improving reliability and extending product life. To ensure trouble-free operation, protection is provided against input surge, input under voltage, input over voltage, output over voltage, short circuit, and over temperature.

Models

Adjustable Output Current Range(mA)	Full-Power Current Range(mA) ⁽¹⁾	Default Output Current(mA)	Output Voltage Range(Vdc)	Max. Output Power(W)	Typical Efficiency ⁽²⁾	Typical Power Factor		Model Number ⁽³⁾⁽⁵⁾
						277Vac	480Vac	
70-1050	700-1050	700	72-214	150	93.0%	0.99	0.96	ESM-150S105Bx
105-1500	1050-1500	1050	50-143	150	93.0%	0.99	0.96	ESM-150S150Bx
140-2100	1400-2100	1400	36-107	150	92.5%	0.99	0.96	ESM-150S210Bx ⁽⁴⁾
280-4200	2800-4200	3150	18-54	150	92.0%	0.99	0.96	ESM-150S420Bx ⁽⁴⁾

Notes: (1) Output current range with constant power at 150W.

(2) Measured at 100% load and 480Vac input (see below "General Specifications" for details).

(3) Certified input voltage range: 277-480Vac.

(4) SELV output.

(5) x = G are UL Recognized, ENEC, etc. models; x = T are UL Class P models.

I-V Operation Area

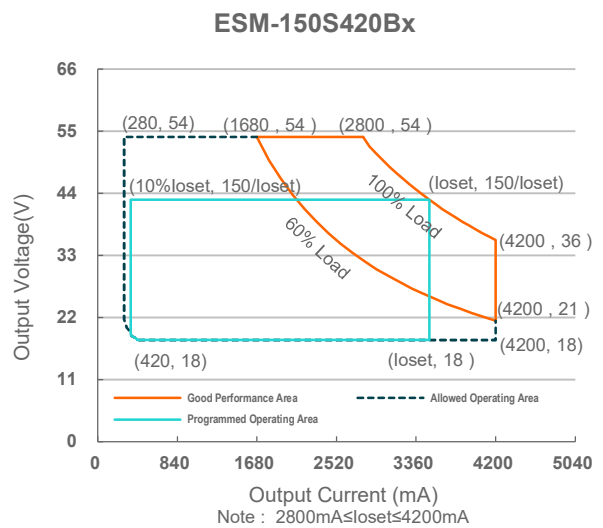
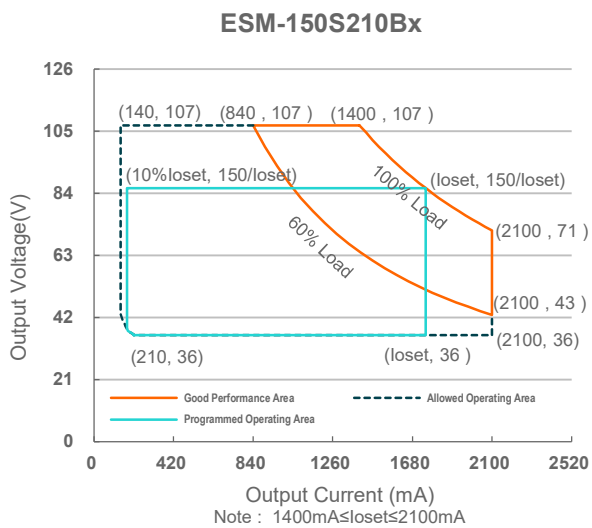
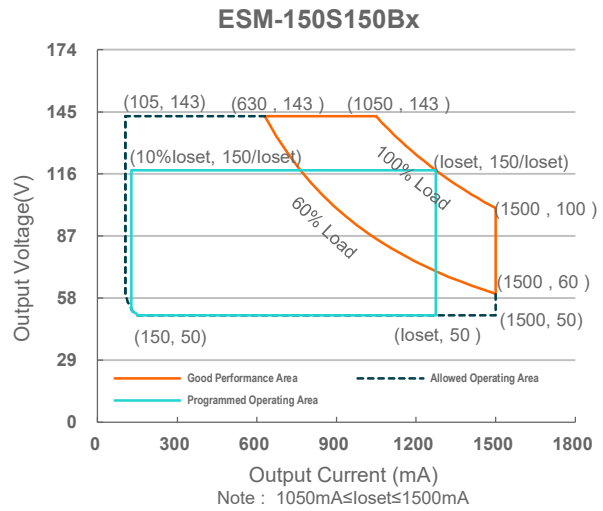
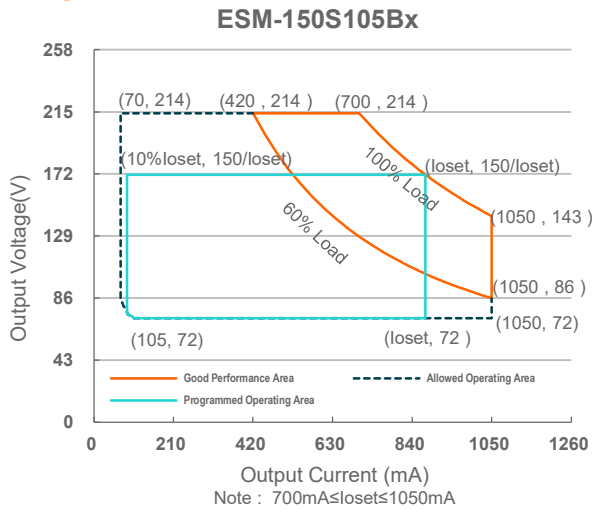

Input Specifications

Parameter	Min.	Typ.	Max.	Notes
Input AC Voltage	249 Vac	-	528 Vac	
Input DC Voltage	352 Vdc	-	500 Vdc	
Input Frequency	47 Hz	-	63 Hz	
Leakage Current	-	-	0.75 MIU	UL 8750; 480Vac/ 60Hz
	-	-	0.70 mA	IEC 60598-1; 480Vac/ 60Hz
Input AC Current	-	-	0.68 A	Measured at 100% load and 277 Vac input.
	-	-	0.40 A	Measured at 100% load and 480 Vac input.
Inrush Current(I ² t)	-	-	1.95 A ² s	At 480Vac input, 25°C cold start, duration=368 μs, 10%I _{pk} -10%I _{pk} .

Input Specifications (Continued)

Parameter	Min.	Typ.	Max.	Notes
PF	0.9	-	-	At 277-480Vac, 50-60Hz, 60%-100% Load (90-150W)
THD	-	-	20%	

Output Specifications

Parameter	Min.	Typ.	Max.	Notes
Output Current Tolerance	-5%loset	-	5%loset	At 100% load condition
Output Current Setting(loset) Range				
ESM-150S105Bx	70 mA	-	1050 mA	
ESM-150S150Bx	105 mA	-	1500 mA	
ESM-150S210Bx	140 mA	-	2100 mA	
ESM-150S420Bx	280 mA	-	4200 mA	
Output Current Setting Range with Constant Power				
ESM-150S105Bx	700 mA	-	1050 mA	
ESM-150S150Bx	1050 mA	-	1500 mA	
ESM-150S210Bx	1400 mA	-	2100 mA	
ESM-150S420Bx	2800 mA	-	4200 mA	
Total Output Current Ripple (pk-pk)	-	5%lomax	10%lomax	At 100% load condition. 20 MHz BW
Output Current Ripple at < 200 Hz (pk-pk)	-	2%lomax	-	At 100% load condition. Only this component of ripple is associated with visible flicker.
Startup Overshoot Current	-	-	10%lomax	At 100% load condition
No Load Output Voltage				
ESM-150S105Bx	-	-	270 V	
ESM-150S150Bx	-	-	180 V	
ESM-150S210Bx	-	-	120 V	
ESM-150S420Bx	-	-	70 V	
Line Regulation	-	-	±0.5%	Measured at 100% load
Load Regulation	-	-	±3.0%	
Turn-on Delay Time	-	-	0.5 s	Measured at all dimming modes except DALI-2, and 277-480Vac input, 60%-100% Load
	-	-	1.0 s	Measured at DALI-2 dimming mode, and 277-480Vac input, 60%-100% Load
Temperature Coefficient of loset	-	0.03%/°C	-	Case temperature = 0°C~Tc max
24V Auxiliary Output Voltage	21.6 V	24 V	26.4 V	
24V Auxiliary Output Source Current	0 mA	-	125 mA	Return terminal is "DA-"
24V Auxiliary Output Transient Peak Current@6W	-	-	250 mA	250mA peak for a maximum duration of 2.2ms in a 6.0ms period during which time the average should not exceed 125mA.
24V Auxiliary Output Transient Peak Current@10W	-	-	425 mA	425mA peak for a maximum duration of 1.3ms in a 5.2ms period during which time the average should not exceed 125mA.

Output Specifications (Continued)

Parameter	Min.	Typ.	Max.	Notes
Integrated DALI-2 Bus Power Supply Voltage	12 Vdc	16 Vdc	20 Vdc	Voltage is depending on loading.
Integrated DALI-2 Bus Power Maximum Supply Current		60 mA		
Integrated DALI-2 Bus Power Guaranteed Supply Current		50 mA		DALI-2 Bus Power Supply Voltage ≥12V

Notes: (1) DALI-2 bus power supply is enabled by default and can be disabled via programming interface.
 (2) DALI-2 bus power supply supports automatic shut-down and restart after short-circuit.

General Specifications

Parameter	Min.	Typ.	Max.	Notes
Efficiency at 277 Vac input: ESM-150S105Bx				Measured at 100% load and steady-state temperature in 25°C ambient; (Efficiency will be about 2.0% lower if measured immediately after startup.)
I _o = 700 mA	90.0%	92.0%	-	
I _o =1050 mA	89.5%	91.5%	-	
ESM-150S150Bx				
I _o =1050 mA	90.0%	92.0%	-	
I _o =1500 mA	89.5%	91.5%	-	
ESM-150S210Bx				
I _o =1400 mA	89.5%	91.5%	-	
I _o =2100 mA	89.5%	91.5%	-	
ESM-150S420Bx				
I _o =2800 mA	89.0%	91.0%	-	
I _o =4200 mA	87.5%	89.5%	-	
Efficiency at 400 Vac input: ESM-150S105Bx				Measured at 100% load and steady-state temperature in 25°C ambient; (Efficiency will be about 2.0% lower if measured immediately after startup.)
I _o = 700 mA	91.0%	93.0%	-	
I _o =1050 mA	90.0%	92.0%	-	
ESM-150S150Bx				
I _o =1050 mA	91.0%	93.0%	-	
I _o =1500 mA	90.5%	92.5%	-	
ESM-150S210Bx				
I _o =1400 mA	90.5%	92.5%	-	
I _o =2100 mA	90.0%	92.0%	-	
ESM-150S420Bx				
I _o =2800 mA	90.0%	92.0%	-	
I _o =4200 mA	88.5%	90.5%	-	
Efficiency at 480 Vac input: ESM-150S105Bx				Measured at 100% load and steady-state temperature in 25°C ambient; (Efficiency will be about 2.0% lower if measured immediately after startup.)
I _o = 700 mA	91.0%	93.0%	-	
I _o =1050 mA	90.5%	92.5%	-	
ESM-150S150Bx				
I _o =1050 mA	91.0%	93.0%	-	
I _o =1500 mA	90.5%	92.5%	-	
ESM-150S210Bx				
I _o =1400 mA	90.5%	92.5%	-	
I _o =2100 mA	90.5%	92.5%	-	
ESM-150S420Bx				
I _o =2800 mA	90.0%	92.0%	-	
I _o =4200 mA	88.5%	90.5%	-	
Power Monitoring Accuracy	-1%	-	1%	Measured at 480Vac input and 100%Load
Standby Power	-	1.5 W	-	Measured at 480Vac/50Hz; Dimming off

General Specifications (Continued)

Parameter	Min.	Typ.	Max.	Notes
MTBF	-	215,000 Hours	-	Measured at 480Vac input, 80%Load and 25°C ambient temperature (MIL-HDBK-217F)
Lifetime	-	100,000 Hours	-	Measured at 480Vac input, 80%Load and 70°C case temperature; See lifetime vs. Tc curve for the details
Operating Case Temperature for Safety Tc_s	-40 °C	-	+90 °C	
Operating Case Temperature for Warranty Tc_w	-40 °C	-	+80 °C	Case temperature for 5 years warranty Humidity: 10% RH to 95% RH
Storage Temperature	-40 °C	-	+85 °C	Humidity: 5%RH to 95%RH
Dimensions Inches (L × W × H) Millimeters (L × W × H)	6.34 × 3.01 × 1.52 161 × 76.5 × 38.5			With mounting ear 7.01 × 3.01 × 1.52 178 × 76.5 × 38.5
Net Weight	-	995 g	-	

Dimming Specifications

Parameter	Min.	Typ.	Max.	Notes	
DA+, DA- High Level	9.5 V	16 V	22.5 V		
DA+, DA- Low Level	-6.5 V	0 V	6.5 V		
DA+, DA- Current	0 mA	-	2 mA		
Dimming Output Range	ESM-150S105Bx ESM-150S150Bx ESM-150S210Bx ESM-150S420Bx	10%loset	-	loset	700 mA ≤ loiset ≤ 1050 mA 1050 mA ≤ loiset ≤ 1500 mA 1400 mA ≤ loiset ≤ 2100 mA 2800 mA ≤ loiset ≤ 4200 mA
	ESM-150S105Bx ESM-150S150Bx ESM-150S210Bx ESM-150S420Bx	70 mA 105 mA 140 mA 280 mA	-	loset	70 mA ≤ loiset < 700 mA 105 mA ≤ loiset < 1050 mA 140 mA ≤ loiset < 1400 mA 280 mA ≤ loiset < 2800 mA

Safety & EMC Compliance

Safety Category	Standard
UL/CUL	UL 8750,CAN/CSA-C22.2 No. 250.13
ENEC	EN 61347-1, EN 61347-2-13
CE	EN 61347-1, EN 61347-2-13 EN 301 489-1 EN 301 489-3 EN 300 330 EN 62479/EN 50663/EN 50665/EN 50364
CB	IEC 61347-1, IEC 61347-2-13
EAC	TP TC 004, TP TC 020

Safety & EMC Compliance (Continued)

Performance	Standard
ENEC	EN IEC 62384
EMI Standards	Notes
EN IEC 55015 ⁽¹⁾	Conducted emission Test & Radiated emission Test
EN IEC 61000-3-2	Harmonic current emissions
EN 61000-3-3	Voltage fluctuations & flicker
FCC Part 15 ⁽¹⁾	ANSI C63.4 Class B
	This device complies with Part 15 of the FCC Rules. Operation is subject to the following two conditions: [1] this device may not cause harmful interference, and [2] this device must accept any interference received, including interference that may cause undesired operation.
EMS Standards	Notes
EN 61000-4-2	Electrostatic Discharge (ESD): 8 kV air discharge, 4 kV contact discharge
EN 61000-4-3	Radio-Frequency Electromagnetic Field Susceptibility Test-RS
EN 61000-4-4	Electrical Fast Transient / Burst-EFT
EN 61000-4-5	Surge Immunity Test: AC Power Line: Differential Mode 6 kV, Common Mode 10 kV
EN 61000-4-6	Conducted Radio Frequency Disturbances Test-CS
EN 61000-4-8	Power Frequency Magnetic Field Test
EN 61000-4-11	Voltage Dips
EN 61547	Electromagnetic Immunity Requirements Applies To Lighting Equipment
DALI-2 Standards	Notes
DALI-2 ⁽²⁾	IEC 62386-101, -102 & -207

Notes: (1) This LED driver meets the EMI specifications above, but EMI performance of a luminaire that contains it depends also on the other devices connected to the driver and on the fixture itself.

(2) DALI parts: 101, 102, 150, 207, 250, 251, 252, 253.

Lifetime vs. Case Temperature

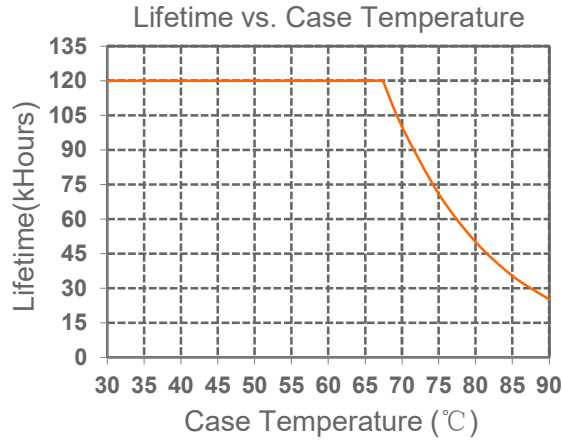

Inrush Current Waveform

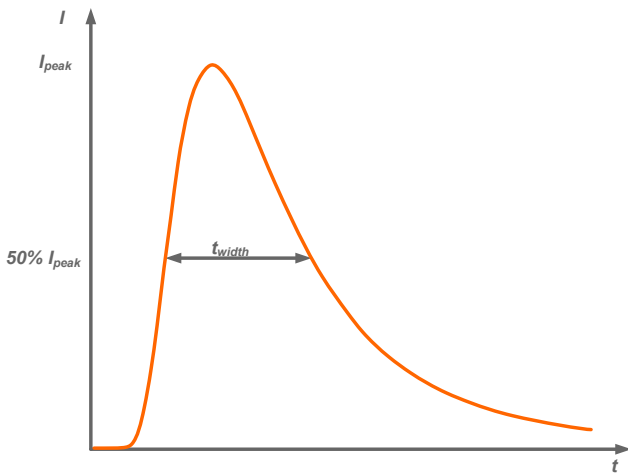

Input AC Voltage	I_{peak}	t_{width} (@ 50% I_{peak})
480Vac	84.0A	164 μ s

Efficiency vs. Load

ESM-150S105Bx($I_o=700mA$)

Efficiency vs. Output Voltage

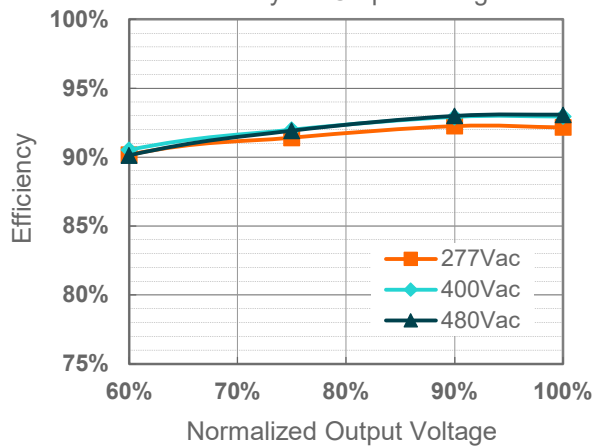

ESM-150S105Bx($I_o=1050mA$)

Efficiency vs. Output Voltage

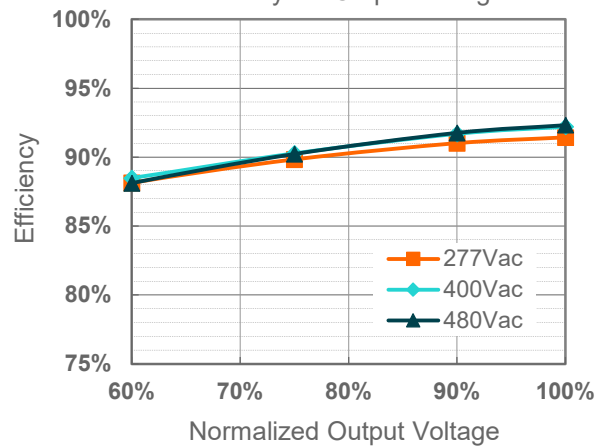

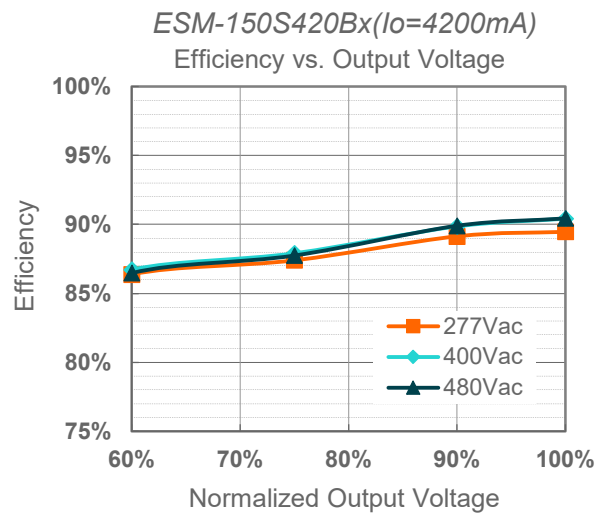
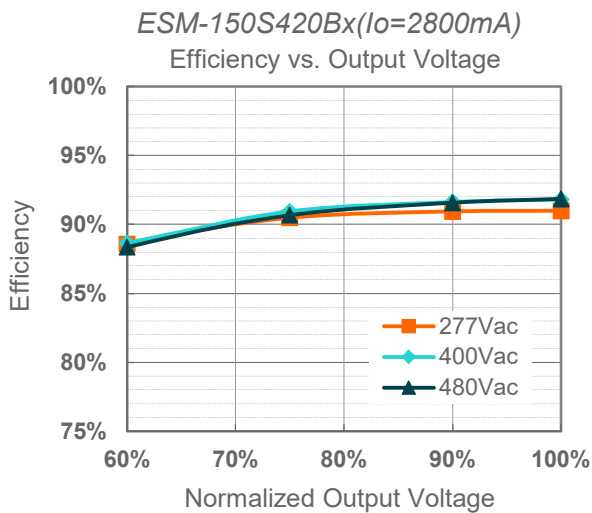
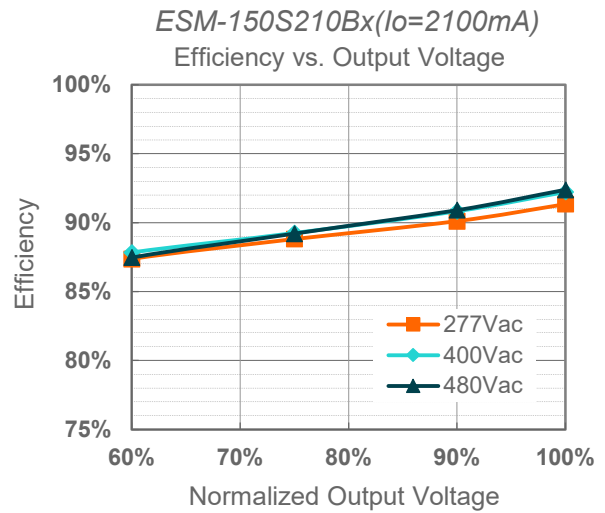
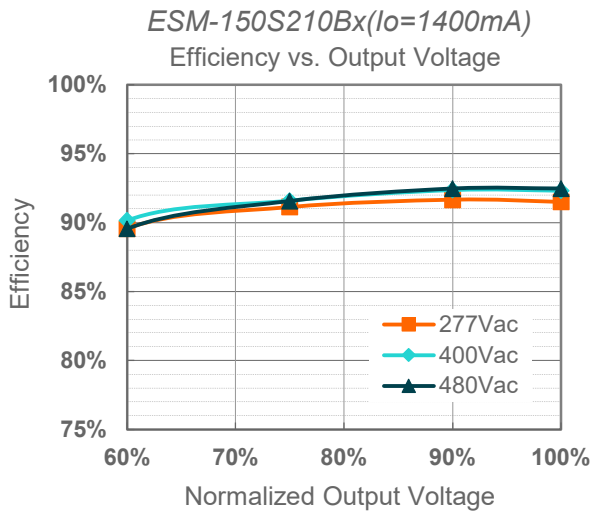
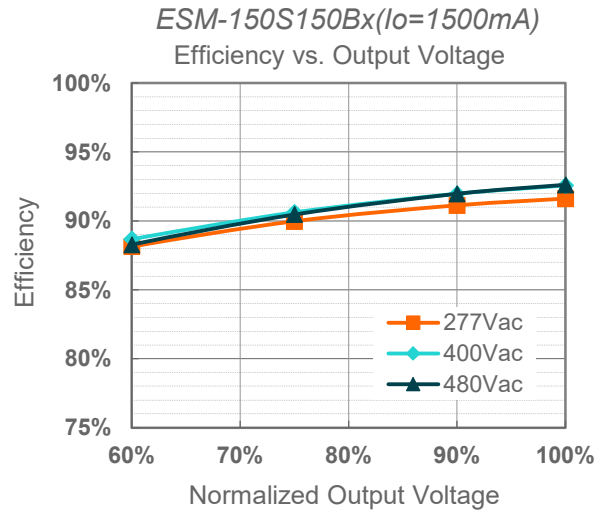
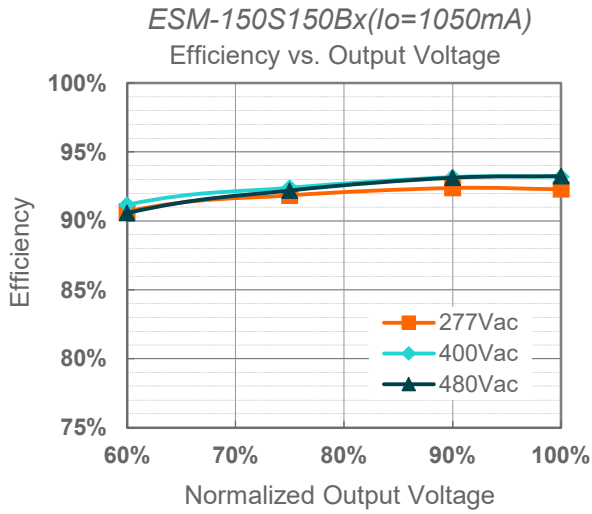

Power Factor

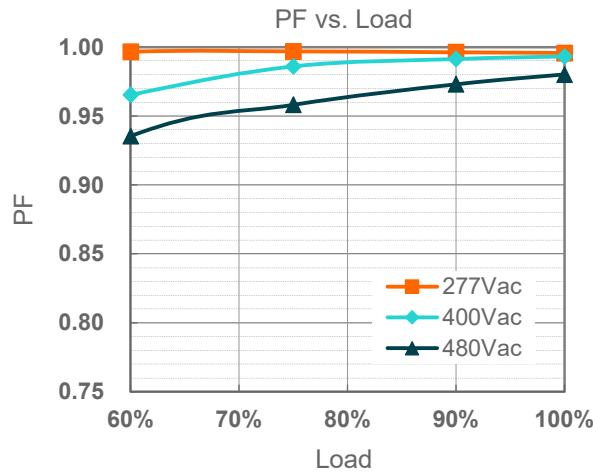

Total Harmonic Distortion

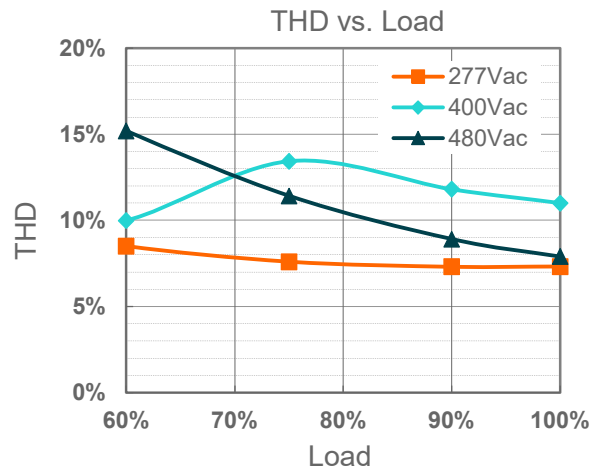

Protection Functions

Parameter		Min.	Typ.	Max.	Notes
External Thermal Protection	R1 (Start derating)	-	1.67 kΩ	-	The output current starts to decrease linearly when the actual NTC resistance value is lower than R1, until R2 is reached.
	R2 (Stop derating)	-	1.27 kΩ	-	When the actual NTC resistance value is lower than R2, the output current will stay at the programmed Protection Current Floor.
	Protection Current Setting Range	10%loset lomin	20%loset	100%loset	10%loset > lomin (default setting is 20%) 10%loset ≤ lomin (default setting is 20%)
Over Voltage Protection		Limits output voltage at no load and in case the normal voltage limit fails.			
Short Circuit Protection		Auto Recovery. No damage will occur when any output is short circuited. The output shall return to normal when the fault condition is removed.			
Over Temperature Protection		Decreases output current, returning to normal after over temperature is removed.			

Protection Functions (Continued)

Parameter		Min.	Typ.	Max.	Notes
Input Under Voltage Protection (IUVP)	Input Under Voltage Protection	220 Vac	230 Vac	240 Vac	Turn off the output when the input voltage falls below protection voltage.
	Input Under Voltage Recovery	230 Vac	240 Vac	250 Vac	Auto Recovery. The driver will restart when the input voltage exceeds recovery voltage.
Input Over Voltage Protection (IOVP)	Input Over Voltage Protection	550 Vac	570 Vac	590 Vac	Turn off the output when the input voltage exceeds protection voltage.
	Input Over Voltage Recovery	530 Vac	550 Vac	570 Vac	Auto Recovery. The driver will restart when the input voltage falls below recovery voltage.
	Max. of Input Over Voltage	-	-	590 Vac	The driver can survive for 8 hours with input voltage stress of 590Vac.

Note: (1) The recommended NTC type is 10kΩ NTC, Murata NCP18XH103J03RB.

● Input Under Voltage Protection Diagram

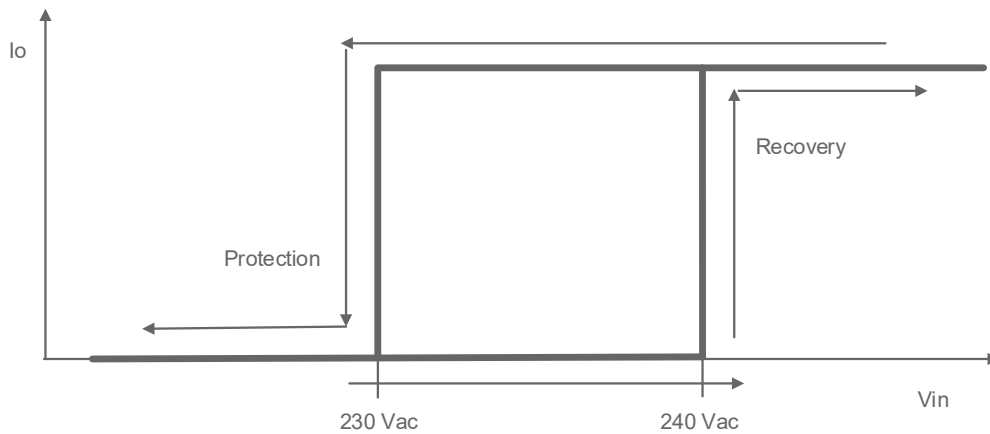

● Input Over Voltage Protection Diagram

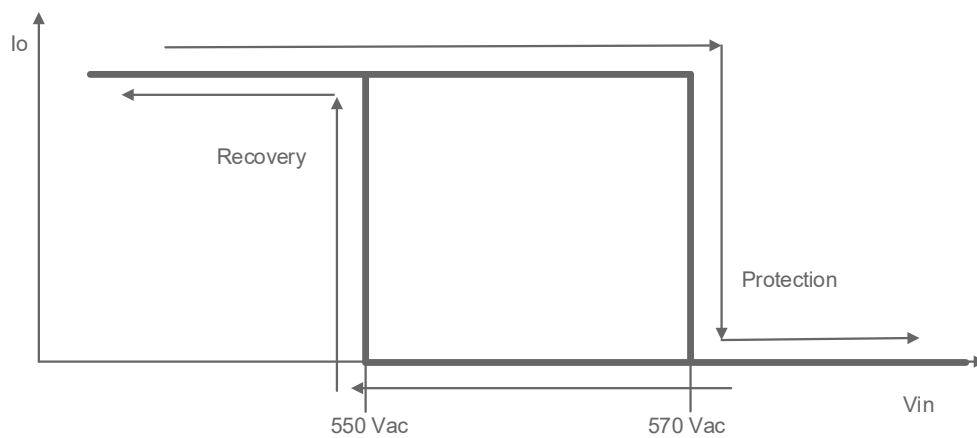

Dimming

● DALI-2 Dimming

The recommended implementation of the dimming control is provided below.

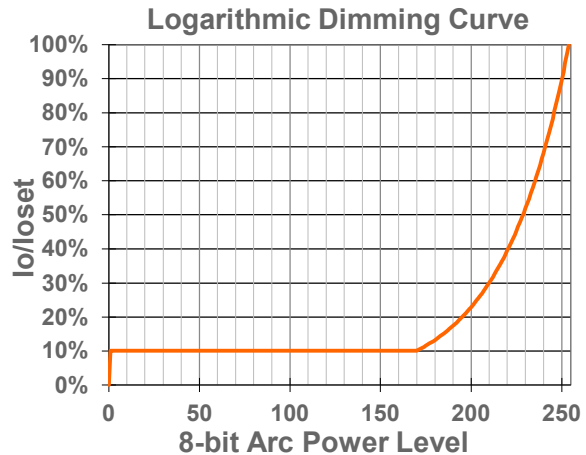
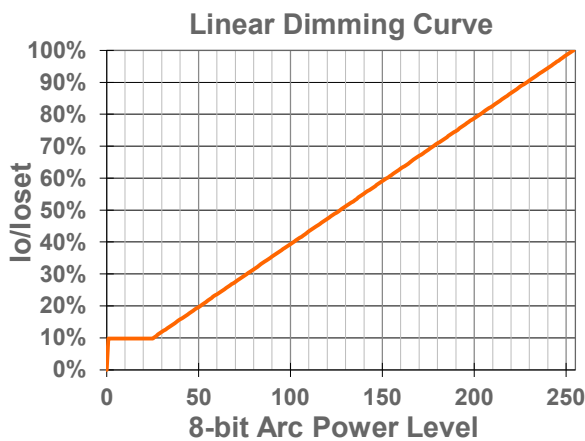
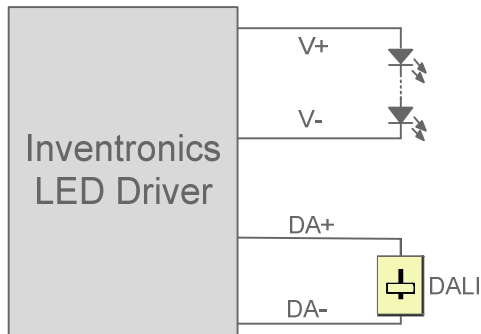

Implementation: DALI-2 Dimming

● Time Dimming

Time dimming control includes 3 kinds of modes, they are Self Adapting-Midnight, Self Adapting-Percentage and Traditional Timer.

- **Self Adapting-Midnight:** Automatically adjusts the dimming curve based on the on-time of past two days (if difference <15 minutes), assuming that the center point of the dimming curve is midnight local time.
- **Self Adapting-Percentage:** Automatically adjusts the on-time of each step by a constant percentage = (actual on-time for the past 2 days if difference <15 min) / (programmed on-time from the dimming curve).
- **Traditional Timer:** Follows the programmed timing curve after power on with no changes.

● Output Lumen Compensation

Output Lumen Compensation (OLC) may be used to maintain constant light output over the life of the LEDs by driving them at a reduced current when new, then gradually increasing the drive current over time to counteract LED lumen degradation.

● End Of Life

End-of-Life (EOL) is providing a visual notification to a user that the LED module has reached the end of manufacturer-specified life and that the replacement is recommended. Once active, an indication is given at each power-up of the driver, which the driver indicates this through a lower light output during the first 1 minute before normal operation is continued.

Programming Connection Diagram

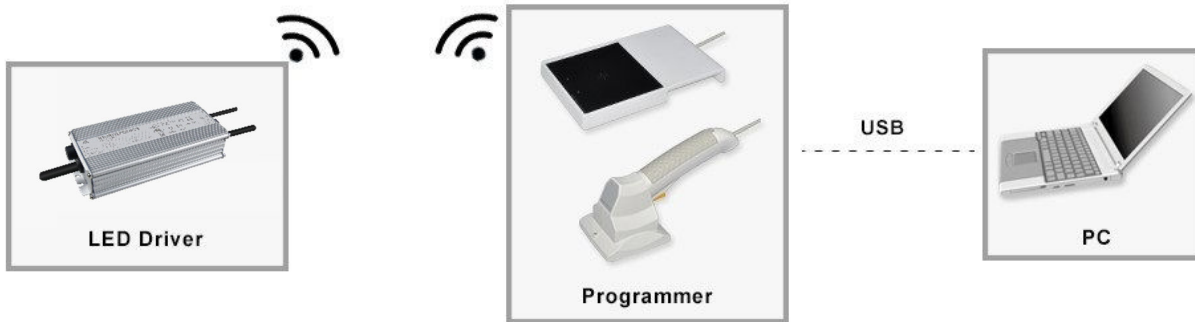

Note: The driver does not need to be powered on during the programming process.

● Please refer to [PRG-NFC-H](#) or [PRG-NFC-D2](#) (Programmer) datasheet for details.

Mechanical Outline

ESM-150SxxxBG

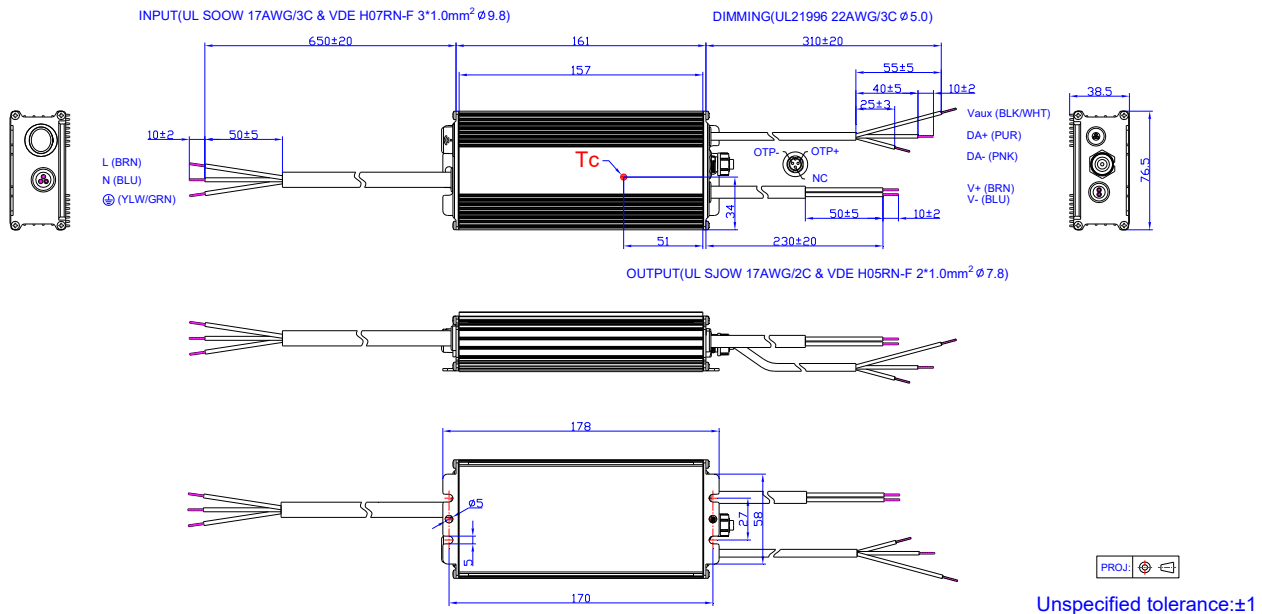

ESM-150SxxxBT

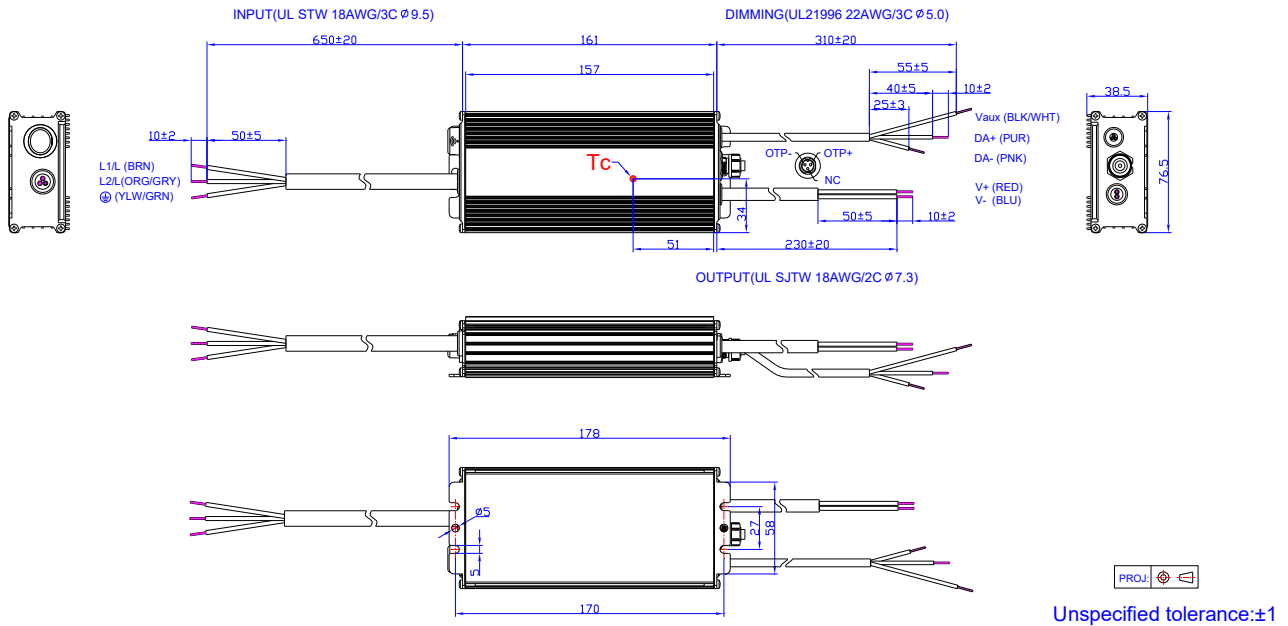

Optional Cable Parts CAB-OTPG

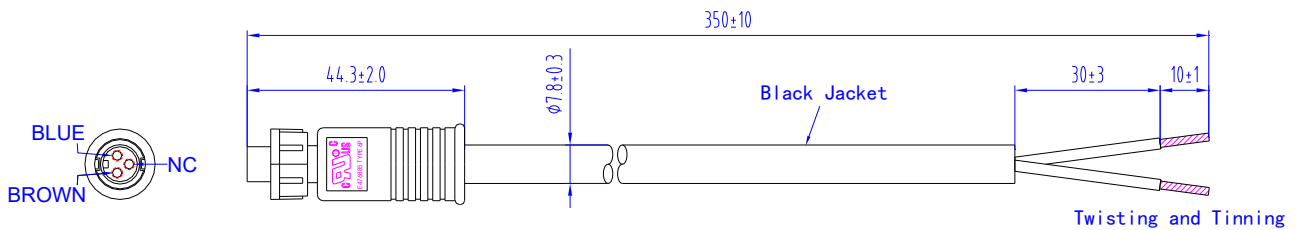

- The external thermal protection cable used for the ESM series drivers can be supplied by Inventronics, please contact the sales for ordering if necessary. For the details of cable, please refer to [CAB-OTPG](#) (Cable) datasheet.

RoHS Compliance

Our products comply with reference to RoHS Directive (EU) 2015/863 amending 2011/65/EU, calling for the elimination of lead and other hazardous substances from electronic products.

Revision History

Change Date	Rev.	Description of Change		
		Item	From	To
2021-05-21	A	Datasheet Release	/	/
2022-01-26	B	UKCA / EAC / NOM logo	/	Added
		Safety & EMC Compliance	/	Updated
		Mechanical Outline	/	Updated
2023-07-17	C	Product Photograph	/	Updated
		Output Specifications	/	Updated
		Safety & EMC Compliance	/	Updated
		Dimming	/	Updated
		Mechanical Outline	/	Updated
2026-03-10	D	Format	/	Updated
		Product Photograph	/	Updated
		UKCA/NOM logo	/	Deleted
		Safety & EMC Compliance	/	Updated
		Inrush Current Waveform	/	Updated