

Features

- Full Power at Wide Output Current Range (Constant Power)
- Adjustable Output Current (AOC) with Programmability
- Isolated 0-10V/PWM/3-Timer-Modes Dimmable
- INV Digital Dimming, UART Based Communication Protocol
- Dim-to-Off with Standby Power $\leq 1.5W$
- Always-on Auxiliary Power: 12Vdc, 250mA, 3W (Transient Peak Power up to 10W)
- Low Inrush Current
- Output Lumen Compensation
- End-of-Life Indicator
- Input Surge Protection: DM 6kV, CM 10kV
- All-Around Protection: IUVP, IOVP, OVP, SCP, OTP
- IP66/IP67 and UL Dry/Damp/Wet Location
- TYPE HL, for Use in a Class I, Division 2 Hazardous (Classified) Location
- 5 Years Warranty



Description

The ESM-150SxxxMx series is a 150W, constant-current, programmable and IP66/IP67 rated LED driver that operates from 249-528Vac input with excellent power factor. Created for smart lighting application, this family provides an auxiliary voltage and dim-to-off functionality for powering low voltage, wireless controls. The dimming control supports 0-10V dimming as well as two-way communication via Digital Dimming, a UART based communication protocol. The high efficiency of these drivers and compact metal case enables them to run cooler, significantly improving reliability and extending product life. To ensure trouble-free operation, protection is provided against input surge, input under voltage, input over voltage, output over voltage, short circuit, and over temperature.

Models

Adjustable Output Current Range (mA)	Full-Power Current Range (mA) ⁽¹⁾	Default Output Current (mA)	Output Voltage Range (Vdc)	Max. Output Power (W)	Typical Efficiency ⁽²⁾	Typical Power Factor		Model Number ⁽³⁾⁽⁵⁾
						277Vac	480Vac	
70-1050	700-1050	700	72-214	150	93.5%	0.99	0.96	ESM-150S105Mx
105-1500	1050-1500	1050	50-143	150	93.0%	0.99	0.96	ESM-150S150Mx
140-2100	1400-2100	1400	36-107	150	92.5%	0.99	0.96	ESM-150S210Mx ⁽⁴⁾
280-4200	2800-4200	3150	18 - 54	150	92.0%	0.99	0.96	ESM-150S420Mx ⁽⁴⁾

- Notes:** (1) Output current range with constant power at 150W
 (2) Measured at 100% load and 480Vac input (see below "General Specifications" for details).
 (3) Certified input voltage range: 277-480Vac.
 (4) SELV output.
 (5) x = G are UL Recognized, ENEC and CCC, etc. models; x = T are UL Class P models.

I-V Operation Area

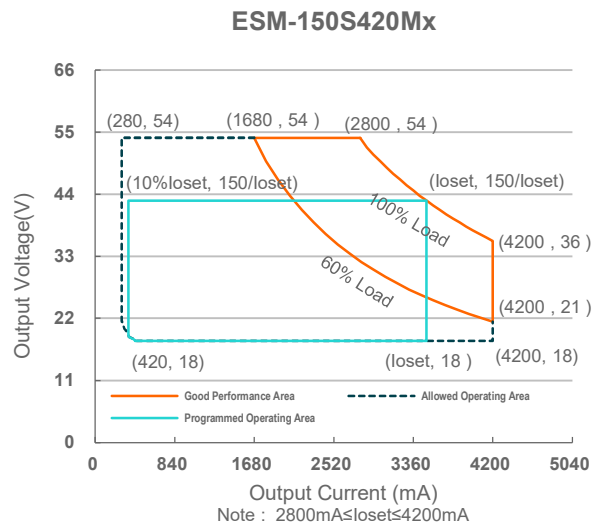
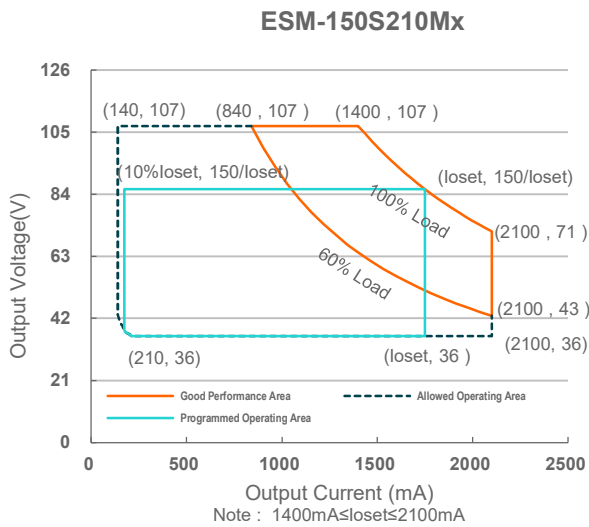
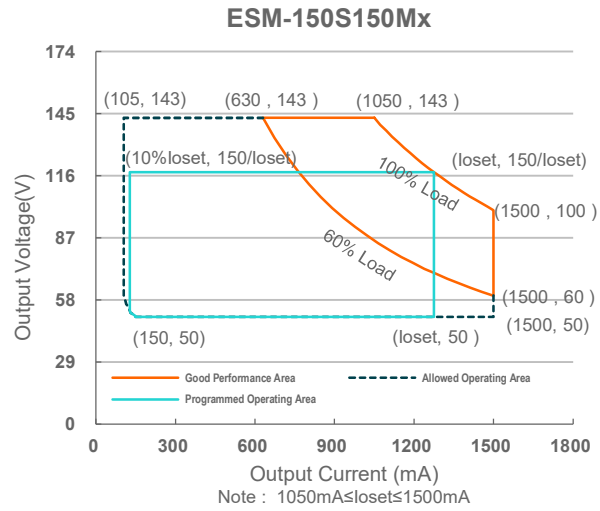
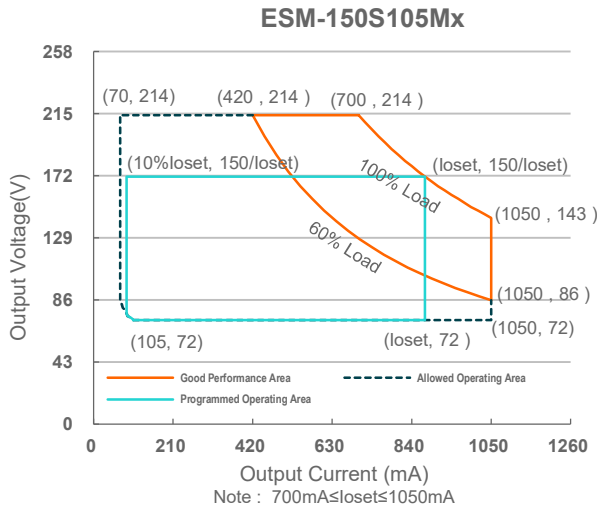

Input Specifications

Parameter	Min.	Typ.	Max.	Notes
Input AC Voltage	249 Vac	-	528 Vac	
Input DC Voltage	352 Vdc	-	500 Vdc	
Input Frequency	47 Hz	-	63 Hz	
Leakage Current	-	-	0.75 MIU	UL 8750; 480Vac/ 60Hz
	-	-	0.70 mA	IEC 60598-1; 480Vac/ 60Hz
Input AC Current	-	-	0.66 A	Measured at 100% load and 277 Vac input.
	-	-	0.38 A	Measured at 100% load and 480 Vac input.

Input Specifications (Continued)

Parameter	Min.	Typ.	Max.	Notes
Inrush Current(I ² t)	-	-	1.95 A ² s	At 480Vac input, 25°C cold start, duration=368 μs, 10%I _{pk} -10%I _{pk} .
PF	0.9	-	-	At 277-480Vac, 50-60Hz, 60%-100% Load (90-150W)
THD	-	-	20%	

Output Specifications

Parameter	Min.	Typ.	Max.	Notes
Output Current Tolerance	-5%loset	-	5%loset	At 100% load condition
Output Current Setting(loset) Range				
ESM-150S105Mx	70 mA	-	1050 mA	
ESM-150S150Mx	105 mA	-	1500 mA	
ESM-150S210Mx	140 mA	-	2100 mA	
ESM-150S420Mx	280 mA	-	4200 mA	
Output Current Setting Range with Constant Power				
ESM-150S105Mx	700 mA	-	1050 mA	
ESM-150S150Mx	1050 mA	-	1500 mA	
ESM-150S210Mx	1400 mA	-	2100 mA	
ESM-150S420Mx	2800 mA	-	4200 mA	
Total Output Current Ripple (pk-pk)	-	5%I _{omax}	10%I _{omax}	At 100% load condition. 20 MHz BW
Output Current Ripple at < 200 Hz (pk-pk)	-	2%I _{omax}	-	At 100% load condition. Only this component of ripple is associated with visible flicker.
Startup Overshoot Current	-	-	10%I _{omax}	At 100% load condition
No Load Output Voltage				
ESM-150S105Mx	-	-	270 V	
ESM-150S150Mx	-	-	180 V	
ESM-150S210Mx	-	-	120 V	
ESM-150S420Mx	-	-	70 V	
Line Regulation	-	-	±0.5%	Measured at 100% load
Load Regulation	-	-	±3.0%	
Turn-on Delay Time	-	-	0.5 s	Measured at 277-480Vac input, 60%-100% Load
Temperature Coefficient of loset	-	0.03%/°C	-	Case temperature = 0°C ~T _c max
12V Auxiliary Output Voltage	10.8 V	12 V	13.2 V	
12V Auxiliary Output Source Current	0 mA	-	250 mA	Return terminal is "Dim"
12V Auxiliary Output Transient Peak Current@6W	-	-	500 mA	500mA peak for a maximum duration of 2.2ms in a 6.0ms period during which time the average should not exceed 250mA.
12V Auxiliary Output Transient Peak Current@10W	-	-	850 mA	850mA peak for a maximum duration of 1.3ms in a 5.2ms period during which time the average should not exceed 250mA.

General Specifications

Parameter	Min.	Typ.	Max.	Notes
Efficiency at 277 Vac input: ESM-150S105Mx				Measured at 100% load and steady-state temperature in 25°C ambient; (Efficiency will be about 2.0% lower if measured immediately after startup.)
Io= 700 mA	90.0%	92.0%	-	
Io=1050 mA	89.5%	91.5%	-	
ESM-150S150Mx				
Io=1050 mA	90.0%	92.0%	-	
Io=1500 mA	89.5%	91.5%	-	
ESM-150S210Mx				
Io=1400 mA	89.5%	91.5%	-	
Io=2100 mA	89.0%	91.0%	-	
ESM-150S420Mx				
Io=2800 mA	89.0%	91.0%	-	
Io=4200 mA	87.5%	89.5%	-	
Efficiency at 400 Vac input: ESM-150S105Mx				Measured at 100% load and steady-state temperature in 25°C ambient; (Efficiency will be about 2.0% lower if measured immediately after startup.)
Io= 700 mA	91.0%	93.0%	-	
Io=1050 mA	90.5%	92.5%	-	
ESM-150S150Mx				
Io=1050 mA	91.0%	93.0%	-	
Io=1500 mA	90.5%	92.5%	-	
ESM-150S210Mx				
Io=1400 mA	90.5%	92.5%	-	
Io=2100 mA	90.0%	92.0%	-	
ESM-150S420Mx				
Io=2800 mA	90.0%	92.0%	-	
Io=4200 mA	88.5%	90.5%	-	
Efficiency at 480 Vac input: ESM-150S105Mx				Measured at 100% load and steady-state temperature in 25°C ambient; (Efficiency will be about 2.0% lower if measured immediately after startup.)
Io= 700 mA	91.5%	93.5%	-	
Io=1050 mA	90.5%	92.5%	-	
ESM-150S150Mx				
Io=1050 mA	91.0%	93.0%	-	
Io=1500 mA	90.5%	92.5%	-	
ESM-150S210Mx				
Io=1400 mA	90.5%	92.5%	-	
Io=2100 mA	90.0%	92.0%	-	
ESM-150S420Mx				
Io=2800 mA	90.0%	92.0%	-	
Io=4200 mA	88.5%	90.5%	-	
Standby Power	-	1.5 W	-	Measured at 480Vac/50Hz; Dimming off
MTBF	-	215,000 Hours	-	Measured at 480Vac input, 80%Load and 25°C ambient temperature (MIL-HDBK-217F)
Lifetime	-	100,000 Hours	-	Measured at 480Vac input, 80%Load and 70°C case temperature; See lifetime vs. Tc curve for the details
Operating Case Temperature for Safety Tc_s	-40°C	-	+90°C	
Operating Case Temperature for Warranty Tc_w	-40°C	-	+80°C	Case temperature for 5 years warranty Humidity: 10% RH to 95% RH;
Storage Temperature	-40°C	-	+85°C	Humidity: 5%RH to 95%RH
Dimensions				With mounting ear
Inches (L × W × H)	6.34 × 3.01 × 1.52			7.01 × 3.01 × 1.52
Millimeters (L × W × H)	161 × 76.5 × 38.5			178 × 76.5 × 38.5
Net Weight	-	995 g	-	

Dimming Specifications

Parameter		Min.	Typ.	Max.	Notes
Absolute Maximum Voltage on the Vdim (+) Pin		-20 V	-	20 V	
Source Current on Vdim (+)Pin		200 μ A	300 μ A	450 μ A	Vdim(+) = 0 V
Dimming Output Range	ESM-150S105Mx ESM-150S150Mx ESM-150S210Mx ESM-150S420Mx	10%loset	-	loset	700 mA \leq loiset \leq 1050 mA 1050 mA \leq loiset \leq 1500 mA 1400 mA \leq loiset \leq 2100 mA 2800 mA \leq loiset \leq 4200 mA
	ESM-150S105Mx ESM-150S150Mx ESM-150S210Mx ESM-150S420Mx	70 mA 105 mA 140 mA 280 mA	-	loset	70 mA \leq loiset < 700 mA 105 mA \leq loiset < 1050 mA 140 mA \leq loiset < 1400 mA 280 mA \leq loiset < 2800 mA
Recommended Dimming Input Range		0 V	-	10 V	Default 0-10V dimming mode.
Dim off Voltage		0.35 V	0.5 V	0.65 V	
Dim on Voltage		0.55 V	0.7 V	0.85 V	
Hysteresis		-	0.2 V	-	
PWM_in High Level		3 V	-	10 V	Dimming mode set to PWM in Inventronics Programing Software.
PWM_in Low Level		-0.3 V	-	0.6 V	
PWM_in Frequency Range		200 Hz	-	3 KHz	
PWM_in Duty Cycle		1%	-	99%	
PWM Dimming off (Positive Logic)		3%	5%	8%	
PWM Dimming on (Positive Logic)		5%	7%	10%	
PWM Dimming off (Negative Logic)		92%	95%	97%	
PWM Dimming on (Negative Logic)		90%	93%	95%	
Hysteresis		-	2%	-	

Safety & EMC Compliance

Safety Category	Standard
UL/CUL	UL 8750,CAN/CSA-C22.2 No. 250.13
ENEC & CE	EN 61347-1, EN 61347-2-13
CB	IEC 61347-1, IEC 61347-2-13
EAC	TP TC 004, TP TC 020

Safety & EMC Compliance (Continued)

Performance	Standard
ENEC	EN IEC 62384
EMI Standards	Notes
EN IEC 55015 ⁽¹⁾	Conducted emission Test & Radiated emission Test
EN IEC 61000-3-2	Harmonic current emissions
EN 61000-3-3	Voltage fluctuations & flicker
FCC Part 15 ⁽¹⁾	ANSI C63.4 Class B
	This device complies with Part 15 of the FCC Rules. Operation is subject to the following two conditions: [1] this device may not cause harmful interference, and [2] this device must accept any interference received, including interference that may cause undesired operation.
EMS Standards	Notes
EN 61000-4-2	Electrostatic Discharge (ESD): 8 kV air discharge, 4 kV contact discharge
EN 61000-4-3	Radio-Frequency Electromagnetic Field Susceptibility Test-RS
EN 61000-4-4	Electrical Fast Transient / Burst-EFT
EN 61000-4-5	Surge Immunity Test: AC Power Line: Differential Mode 6 kV, Common Mode 10 kV
EN 61000-4-6	Conducted Radio Frequency Disturbances Test-CS
EN 61000-4-8	Power Frequency Magnetic Field Test
EN 61000-4-11	Voltage Dips
EN 61547	Electromagnetic Immunity Requirements Applies To Lighting Equipment

Note: (1) This LED driver meets the EMI specifications above, but EMI performance of a luminaire that contains it depends also on the other devices connected to the driver and on the fixture itself.

Lifetime vs. Case Temperature

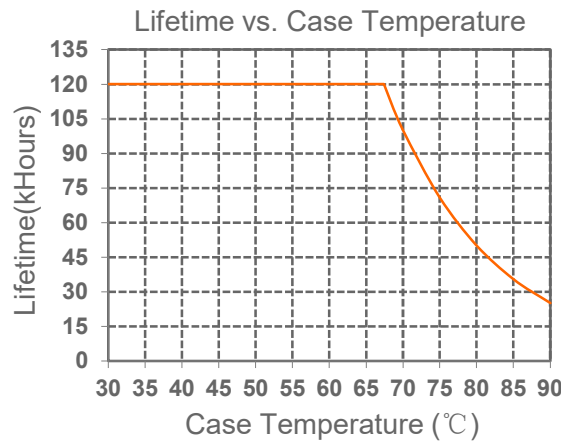

Inrush Current Waveform

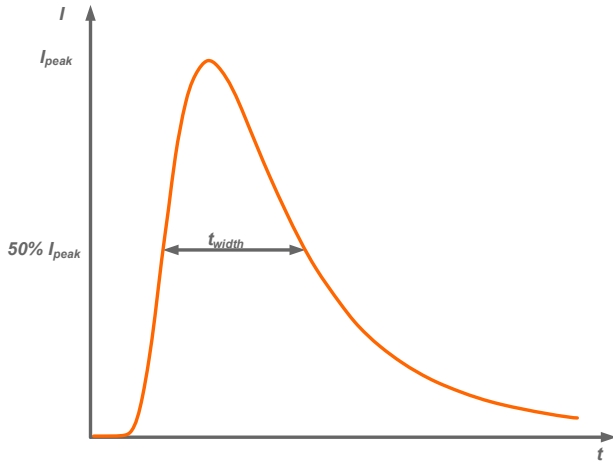

Input AC Voltage	I_{peak}	t_{width} (@ 50% I_{peak})
480 Vac	84.0 A	164 μ s

Efficiency vs. Load

ESM-150S105Mx($I_o=700mA$)

Efficiency vs. Output Voltage

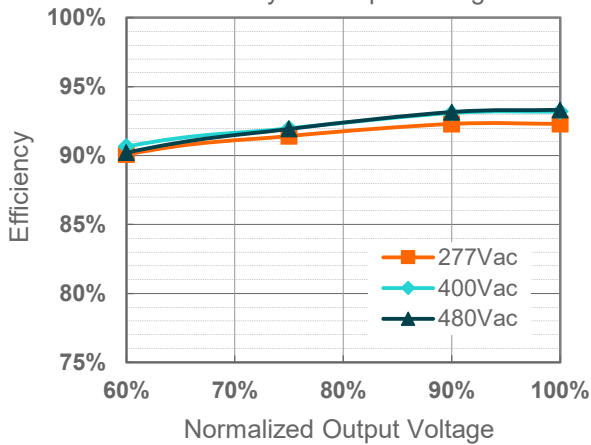

ESM-150S105Mx($I_o=1050mA$)

Efficiency vs. Output Voltage

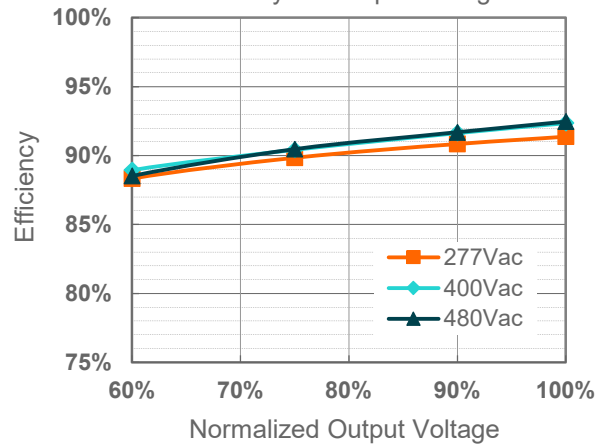

ESM-150S150Mx($I_o=1050mA$)

Efficiency vs. Output Voltage

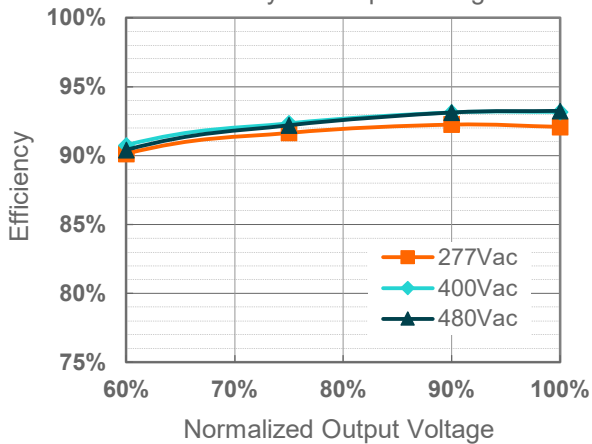

ESM-150S150Mx($I_o=1500mA$)

Efficiency vs. Output Voltage

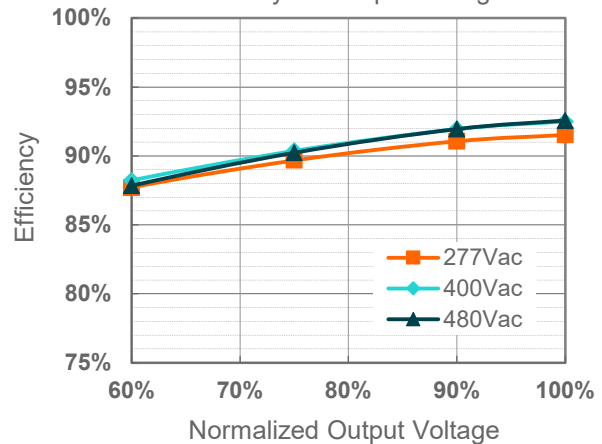

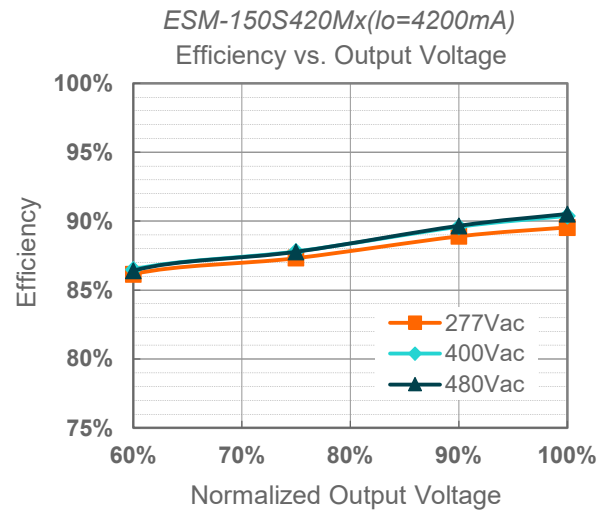
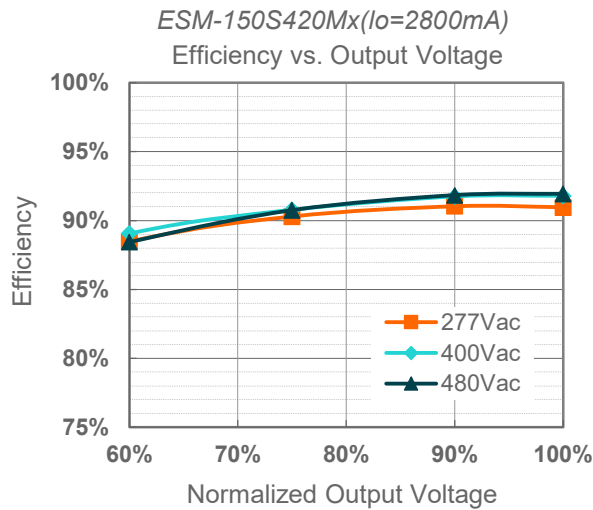
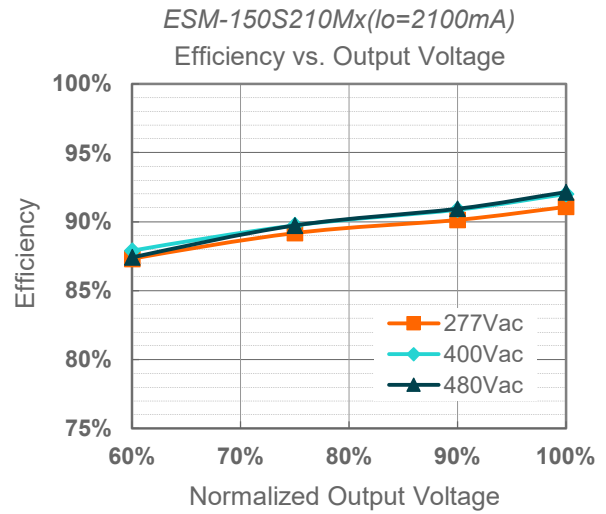
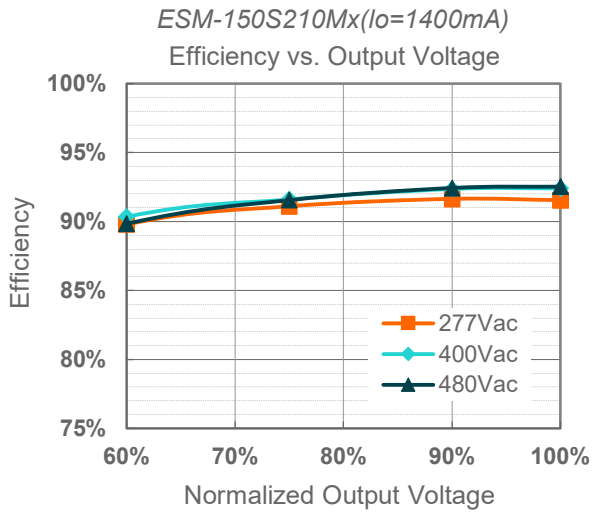

Power Factor

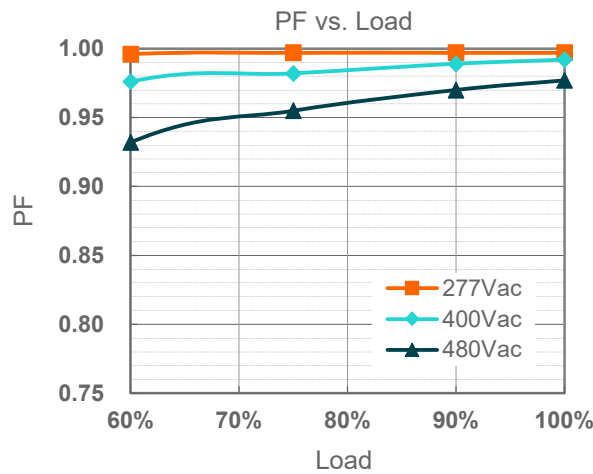

Total Harmonic Distortion

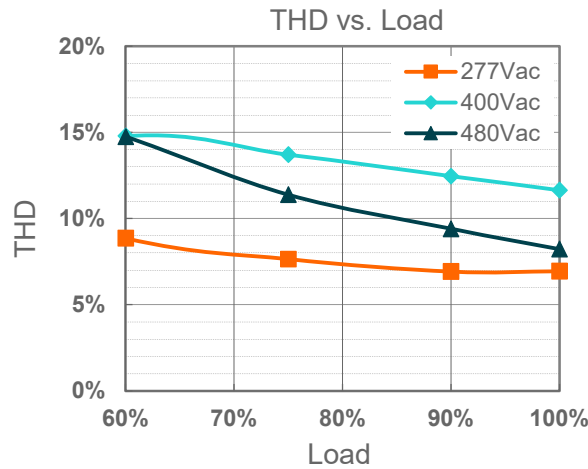

Protection Functions

Parameter		Min.	Typ.	Max.	Notes
Over Voltage Protection		Limits output voltage at no load and in case the normal voltage limit fails.			
Short Circuit Protection		Auto Recovery. No damage will occur when any output is short circuited. The output shall return to normal when the fault condition is removed.			
Over Temperature Protection		Decreases output current, returning to normal after over temperature is removed.			
Input Under Voltage Protection (IUVP)	Input Under Voltage Protection	220 Vac	230 Vac	240 Vac	Turn off the output when the input voltage falls below protection voltage.
	Input Under Voltage Recovery	230 Vac	240 Vac	250 Vac	Auto Recovery. The driver will restart when the input voltage exceeds recovery voltage.
Input Over Voltage Protection (IOVP)	Input Over Voltage Protection	550 Vac	570 Vac	590 Vac	Turn off the output when the input voltage exceeds protection voltage.
	Input Over Voltage Recovery	530 Vac	550 Vac	570 Vac	Auto Recovery. The driver will restart when the input voltage falls below recovery voltage.
	Max. of Input Over Voltage	-	-	590 Vac	The driver can survive for 8 hours with input voltage stress of 590Vac.

● Input Under Voltage Protection Diagram

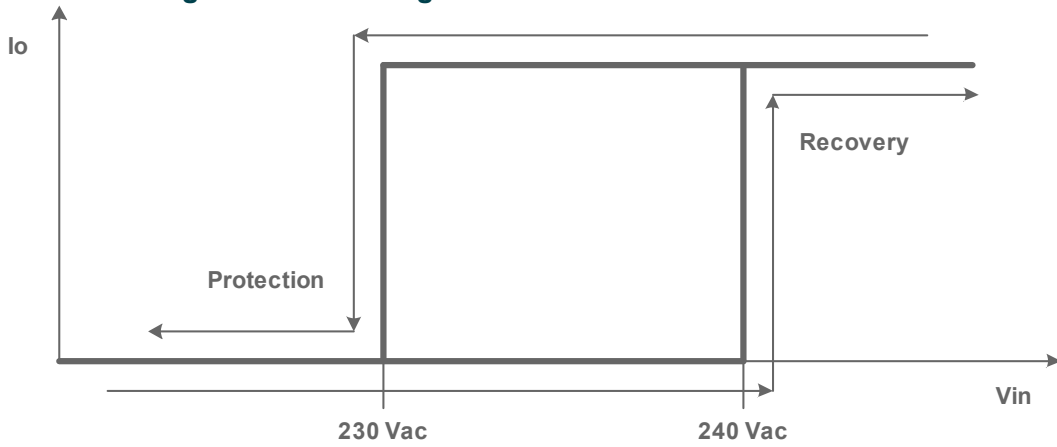

● Input Over Voltage Protection Diagram

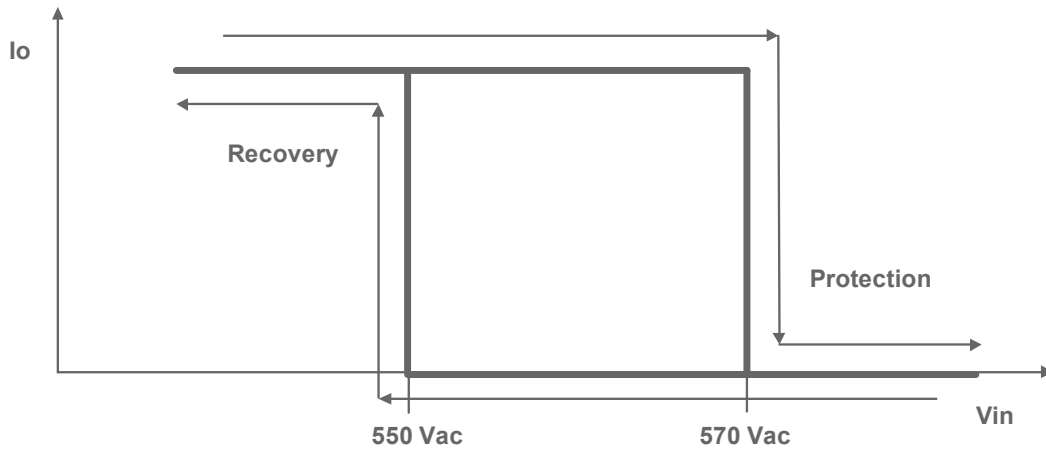

Dimming

● 0-10V Dimming

The recommended implementation of the dimming control is provided below.

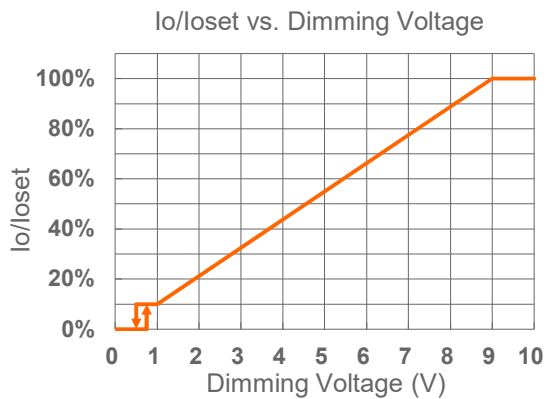
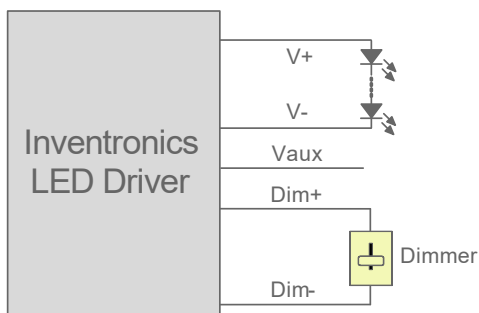

Implementation 1: Positive logic

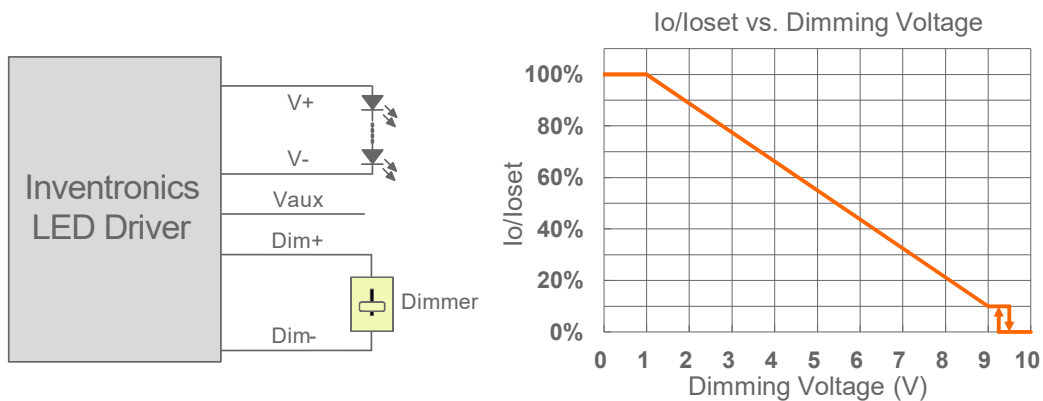

Implementation 2: Negative logic

Notes:

1. Do NOT connect Dim- to the output V- or V+, otherwise the driver will not work properly.
2. The dimmer can also be replaced by an active 0-10V voltage source signal or passive components like zener.
3. When 0-10V negative logic dimming mode and Dim+ is open, the driver will dim to off and be standby.

PWM Dimming

The recommended implementation of the dimming control is provided below.

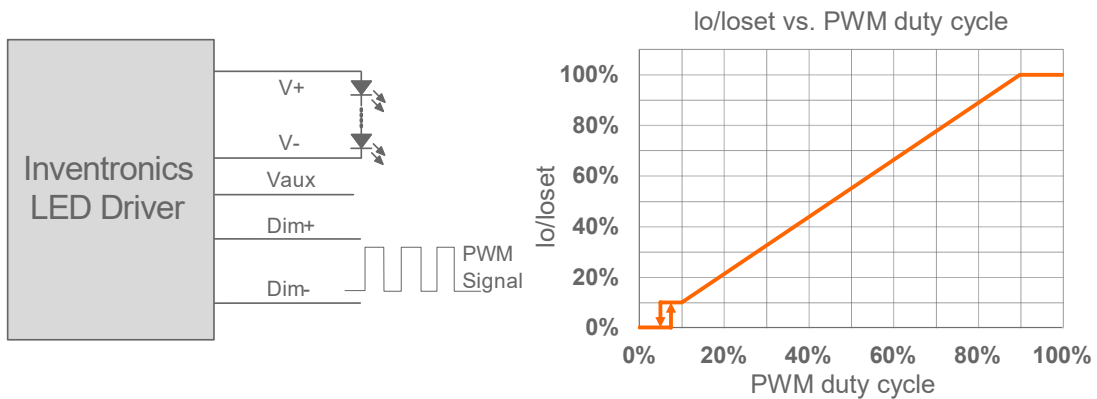

Implementation 3: Positive logic

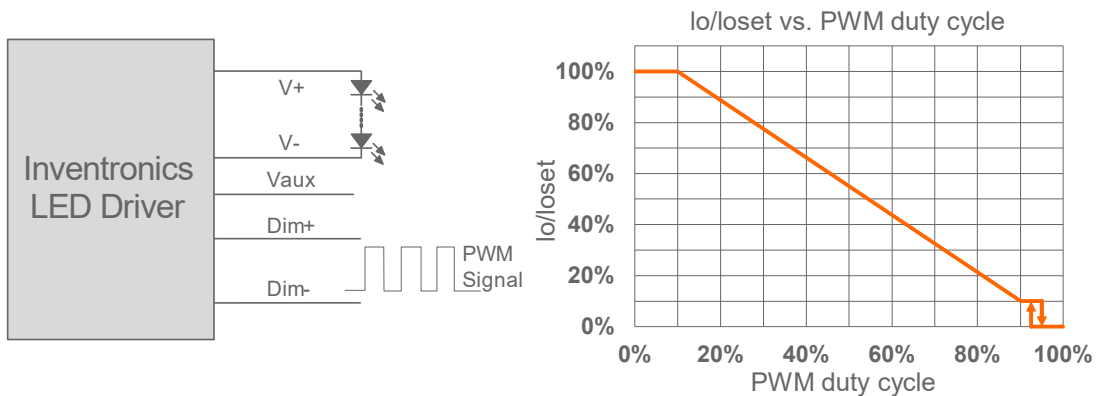

Implementation 4: Negative logic

Note:

1. Do NOT connect Dim- to the output V- or V+, otherwise the driver will not work properly.
2. When PWM negative logic dimming mode and Dim+ is open, the driver will dim to off and be standby.

● **Time Dimming**

Time dimming control includes 3 kinds of modes, they are Self Adapting-Midnight, Self Adapting-Percentage and Traditional Timer.

- **Self Adapting-Midnight:** Automatically adjusts the dimming curve based on the on-time of past two days (if difference <15 minutes), assuming that the center point of the dimming curve is midnight local time.
- **Self Adapting-Percentage:** Automatically adjusts the on-time of each step by a constant percentage = (actual on-time for the past 2 days if difference <15 min) / (programmed on-time from the dimming curve).
- **Traditional Timer:** Follows the programmed timing curve after power on with no changes.

● **Output Lumen Compensation**

Output Lumen Compensation (OLC) may be used to maintain constant light output over the life of the LEDs by driving them at a reduced current when new, then gradually increasing the drive current over time to counteract LED lumen degradation.

● **End Of Life**

End-of-Life (EOL) is providing a visual notification to a user that the LED module has reached the end of manufacturer-specified life and that the replacement is recommended. Once active, an indication is given at each power-up of the driver, which the driver indicates this through a lower light output during the first 1 minute before normal operation is continued.

● **Digital Dimming**

Inventronics Digital Dimming is a UART (Universal Asynchronous Receive Transmitter) based communication protocol. Please refer to [Inventronics Digital Dimming](#) file for details.

Programming Connection Diagram

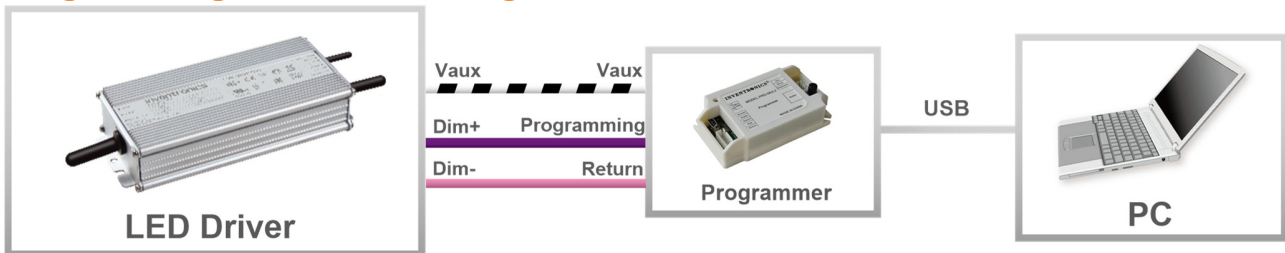

Note: The driver does not need to be powered on during the programming process.

- Please refer to [PRG-MUL2](#) (Programmer) datasheet for details.

Mechanical Outline

ESM-150SxxxMG

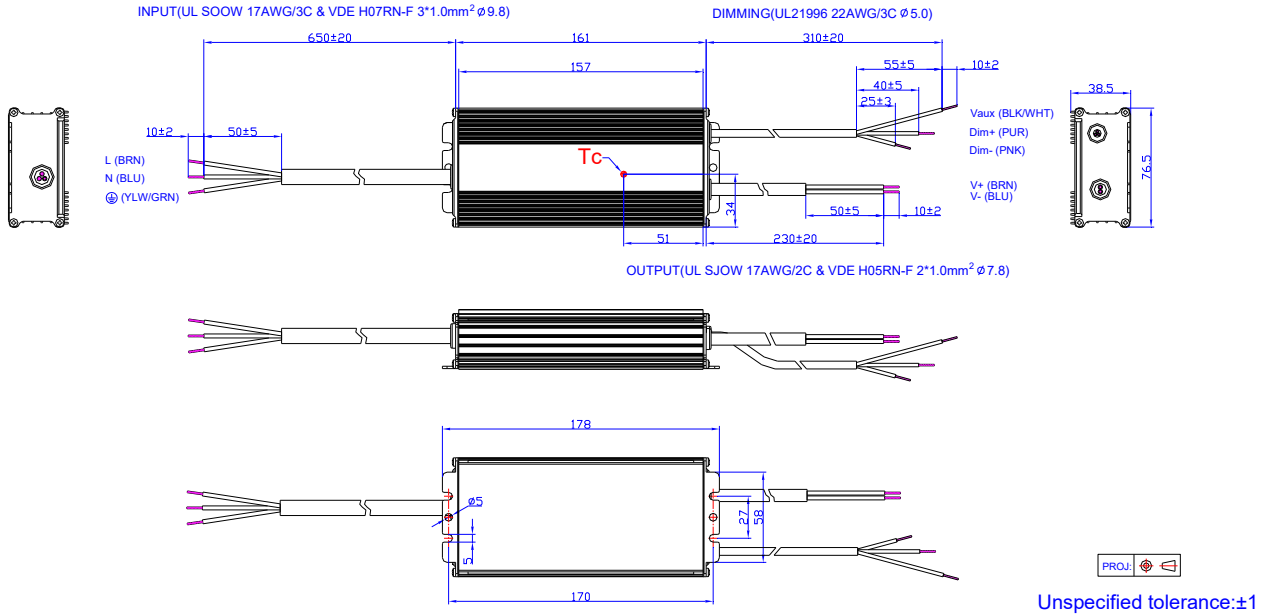

ESM-150SxxxMT

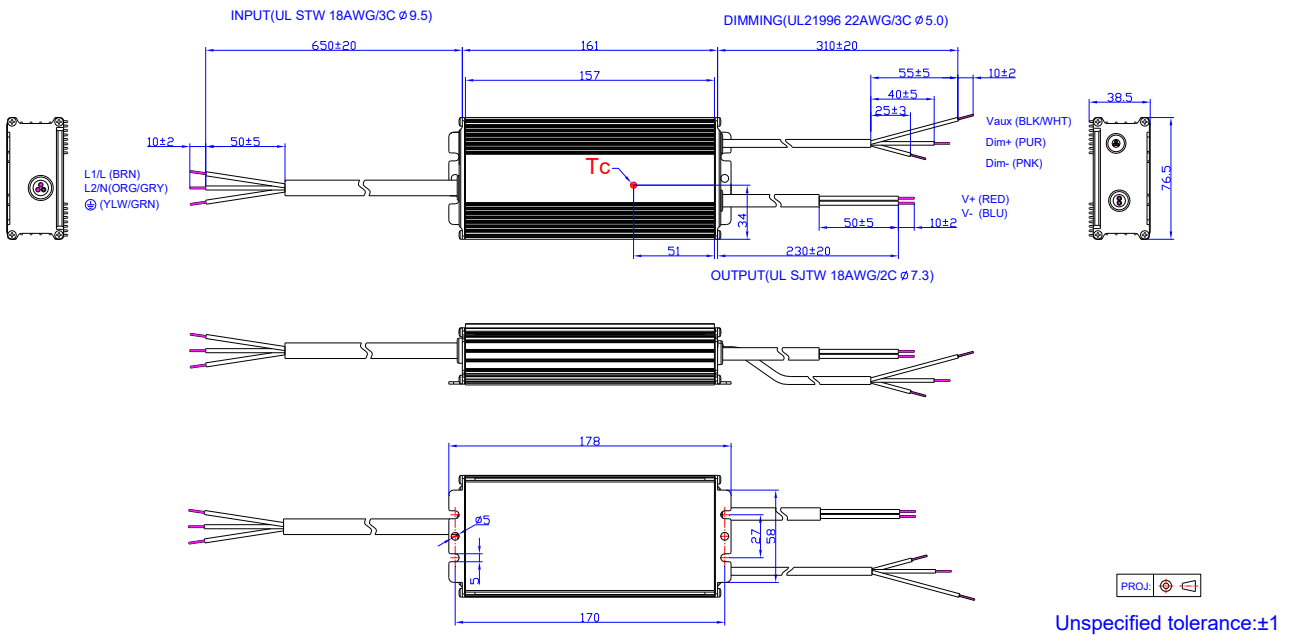

RoHS Compliance

Our products comply with reference to RoHS Directive (EU) 2015/863 amending 2011/65/EU, calling for the elimination of lead and other hazardous substances from electronic products.

Revision History

Change Date	Rev.	Description of Change		
		Item	From	To
2021-09-23	A	Datasheet Release	/	/
2021-09-29	B	Dimming	/	Updated
		Programming Connection Diagram	/	Updated
2023-07-06	C	UKCA/EAC logo	/	Added
		Product Photograph	/	Updated
		Safety & EMC Compliance	/	Updated
		Dimming	/	Updated
		Programming Connection Diagram	/	Updated
		Mechanical Outline	/	Updated
2026-03-18	D	Format	/	Updated
		Product Photograph	/	Updated
		UKCA logo	/	Deleted
		Safety & EMC Compliance	/	Updated
		Inrush Current Waveform	/	Updated