

## Features

- Ultra High Efficiency (Up to 95%)
- Full Power at Wide Output Current Range (Constant Power)
- Thermal Sensing and Protection for LED Module
- Isolated 0-10V/PWM/3 Timer-Modes Dimmable
- Dim-to-Off with Standby Power  $\leq 1.5$  W
- Output Lumen Compensation
- Input Surge Protection: DM 6kV, CM 10kV
- All-Around Protection: OVP, SCP, OTP
- IP67 and UL Dry/Damp/Wet Location
- SELV Output
- TYPE HL, for Use in a Class I, Division 2 Hazardous (Classified) Location
- 5 Years Warranty



## Description

The ESD-480SxxxDT series is a 480W, constant-current, programmable LED driver that operates from 249-528 Vac input with excellent power factor. It is created for many lighting applications including high bay, high mast, aquaculture and sports, etc, it provides a dim-to-off mode with low standby power. The high efficiency of these drivers and compact metal case enables them to run cooler, significantly improving reliability and extending product life. To ensure trouble-free operation, protection is provided against input surge, output over voltage, short circuit, and over temperature.

## Models

Adjustable Output Current Range	Full-Power Current Range(1)	Default Output Current	Input Voltage Range(2)	Output Voltage Range	Max. Output Power	Typical Efficiency (3)	Typical Power Factor		Model Number
							277Vac	480Vac	
0.105-1.40A	1.05A-1.40A	1.4 A	249~528Vac 352~500Vdc	171 ~ 457Vdc	480 W	95.0%	0.96	0.95	ESD-480S140DT <sup>(5)</sup>
0.210-2.80A	2.10-2.80A	2.8 A	249~528Vac 352~500Vdc	86 ~ 228Vdc	480 W	94.5%	0.96	0.95	ESD-480S280DT
0.315-4.20A	3.15-4.20A	4.2 A	249~528Vac 352~500Vdc	57 ~ 152Vdc	480 W	94.0%	0.96	0.95	ESD-480S420DT
0.435-5.60A	4.35-5.60A	5.6 A	249~528Vac 352~500Vdc	43 ~ 110Vdc	480 W	93.5%	0.96	0.95	ESD-480S560DT <sup>(4)</sup>
0.750-10.0A	7.50-10.0A	10.0 A	249~528Vac 352~500Vdc	24 ~ 64Vdc	480 W	93.5%	0.96	0.95	ESD-480S10ADT <sup>(4)</sup>

- Notes:** (1) Output current range with constant power at 480W.  
 (2) Certified input voltage range: 277-480Vac or 352-500Vdc.  
 (3) Measured at 100% load and 480Vac input (see below "General Specifications" for details).  
 (4) SELV output.  
 (5) This model is certificated to KCC.

## I-V Operating Area

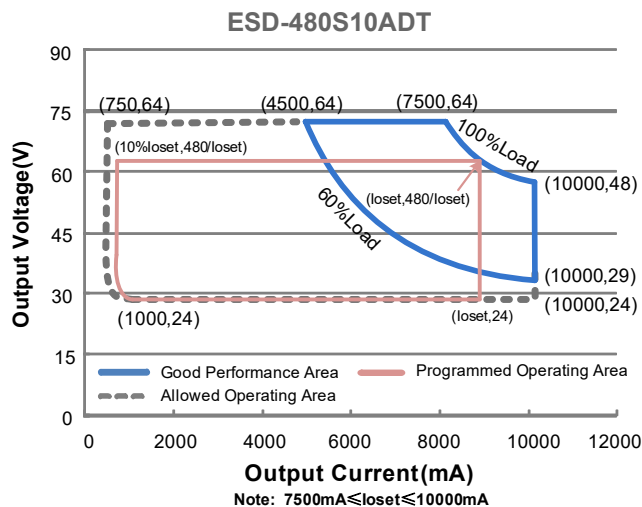
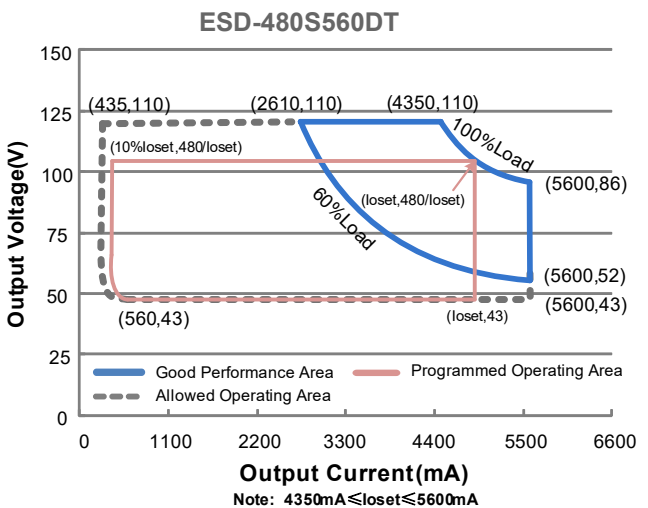
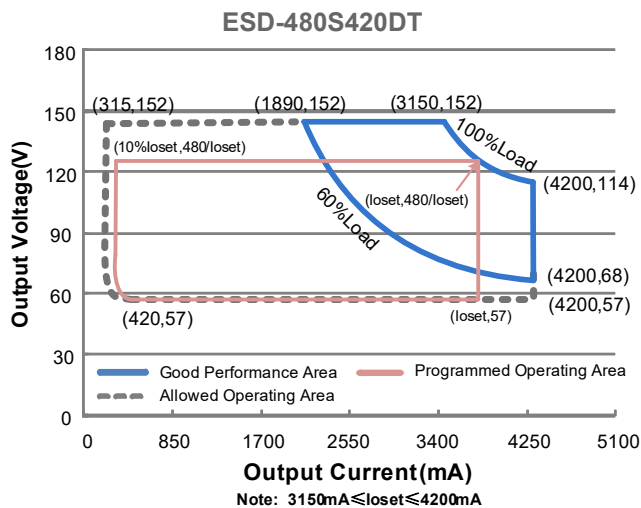
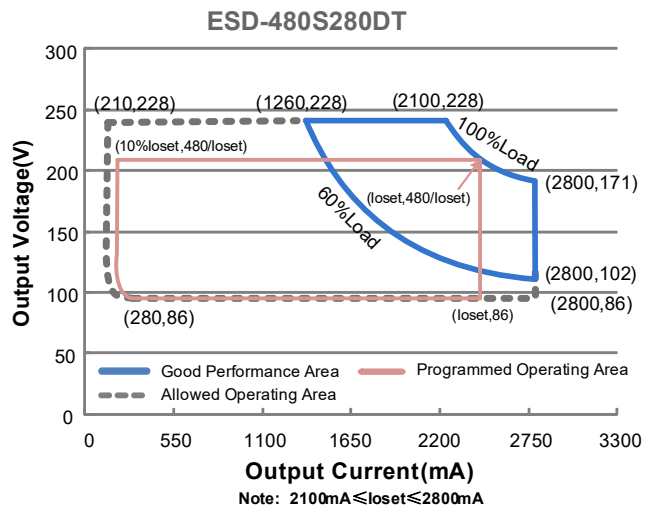
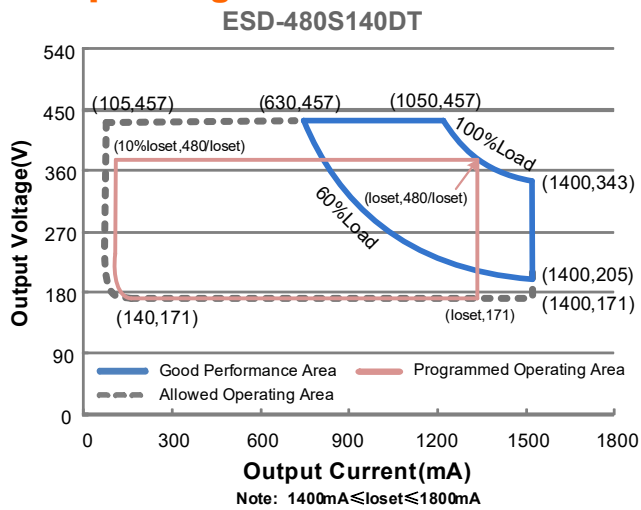

## Input Specifications

Parameter	Min.	Typ.	Max.	Notes
Input AC Voltage	249 Vac	-	528 Vac	
Input DC Voltage	352 Vdc		500 Vdc	
Input Frequency	47 Hz	-	63 Hz	
Leakage Current	-	-	0.75 MIU	UL 8750; 480Vac/60Hz, Grounding effectively
	-	-	0.70 mA	IEC 60598-1; 480Vac/60Hz
Input AC Current	-	-	2.09 A	Measured at 100% load and 277 Vac input.
	-	-	1.21 A	Measured at 100% load and 480 Vac input.
Inrush Current(I <sup>2</sup> t)	-	-	13.8 A <sup>2</sup> s	At 480Vac input, 25°C cold start, duration=840 μs, 10%Ipk-10%Ipk. See Inrush Current Waveform for the details.
PF	0.90	-	-	At 277-480Vac, 50-60Hz, 60%-100% load (288-480W)
THD	-	-	20%	

## Output Specifications

Parameter	Min.	Typ.	Max.	Notes
Output Current Tolerance	-5%loset	-	5%loset	At 100% load condition
Output Current Setting(loset) Range				
ESD-480S140DT	105 mA	-	1400 mA	
ESD-480S280DT	210 mA	-	2800 mA	
ESD-480S420DT	315 mA	-	4200 mA	
ESD-480S560DT	435 mA	-	5600 mA	
ESD-480S10ADT	750 mA	-	10000 mA	
Output Current Setting Range with Constant Power				
ESD-480S140DT	1050 mA	-	1400 mA	
ESD-480S280DT	2100 mA	-	2800 mA	
ESD-480S420DT	3150 mA	-	4200 mA	
ESD-480S560DT	4350 mA	-	5600 mA	
ESD-480S10ADT	7500 mA	-	10000 mA	
Total Output Current Ripple (pk-pk)	-	5%lomax	10%lomax	At 100% load condition, 20 MHz BW
Output Current Ripple at < 200 Hz (pk-pk)	-	2%lomax	-	At 100% load condition. Only this component of ripple is associated with visible flicker.
Startup Overshoot Current	-	-	10%lomax	At 100% load condition
No Load Output Voltage				
ESD-480S140DT	-	-	500 V	
ESD-480S280DT	-	-	280 V	
ESD-480S420DT	-	-	190 V	
ESD-480S560DT	-	-	120 V	
ESD-480S10ADT	-	-	80 V	
Line Regulation	-	-	±0.5%	Measured at 100% load
Load Regulation	-	-	±1.5%	

## Output Specifications (Continued)

Parameter	Min.	Typ.	Max.	Notes
Turn-on Delay Time	-	-	0.5 s	Measured at 277-480Vac input, 60%-100% load
Temperature Coefficient of I <sub>o</sub> set	-	0.03%/°C	-	Case temperature = 0°C~T <sub>c</sub> max
12V Auxiliary Output Voltage	10.8 V	12 V	13.2 V	
12V Auxiliary Output Source Current	0 mA	-	200 mA	Return terminal is "Dim-"
12V Auxiliary Output Transient Peak Current	-	-	400 mA	400mA peak for a maximum duration of 300ms in a 2s period during which time the average should not exceed 200mA.

## General Specifications

Parameter	Min.	Typ.	Max.	Notes
Efficiency at 277 Vac input: ESD-480S140DT				Measured at 100% load and steady-state temperature in 25°C ambient; (Efficiency will be about 2.0% lower if measured immediately after startup.)
I <sub>o</sub> = 1050 mA	92.0%	94.0%	-	
I <sub>o</sub> = 1400 mA	91.5%	93.5%	-	
ESD-480S280DT				
I <sub>o</sub> = 2100 mA	91.5%	93.5%	-	
I <sub>o</sub> = 2800 mA	90.5%	92.5%	-	
ESD-480S420DT				
I <sub>o</sub> = 3150 mA	91.0%	93.0%	-	
I <sub>o</sub> = 4200 mA	90.5%	92.5%	-	
ESD-480S560DT				
I <sub>o</sub> = 4350 mA	90.5%	92.5%	-	
I <sub>o</sub> = 5600 mA	90.0%	92.0%	-	
ESD-480S10ADT				
I <sub>o</sub> = 7500 mA	90.5%	92.5%	-	
I <sub>o</sub> = 10000 mA	89.0%	91.0%	-	
Efficiency at 347 Vac input: ESD-480S140DT				Measured at 100% load and steady-state temperature in 25°C ambient; (Efficiency will be about 2.0% lower if measured immediately after startup.)
I <sub>o</sub> = 1050 mA	92.5%	94.5%	-	
I <sub>o</sub> = 1400 mA	92.0%	94.0%	-	
ESD-480S280DT				
I <sub>o</sub> = 2100 mA	92.0%	94.0%	-	
I <sub>o</sub> = 2800 mA	91.0%	93.0%	-	
ESD-480S420DT				
I <sub>o</sub> = 3150 mA	91.5%	93.5%	-	
I <sub>o</sub> = 4200 mA	91.0%	93.0%	-	
ESD-480S560DT				
I <sub>o</sub> = 4350 mA	91.0%	93.0%	-	
I <sub>o</sub> = 5600 mA	90.5%	92.5%	-	
ESD-480S10ADT				
I <sub>o</sub> = 7500 mA	91.0%	93.0%	-	
I <sub>o</sub> = 10000 mA	89.5%	91.5%	-	

## General Specifications (Continued)

Parameter	Min.	Typ.	Max.	Notes
Efficiency at 480 Vac input: ESD-480S140DT I <sub>o</sub> = 1050 mA I <sub>o</sub> = 1400 mA ESD-480S280DT I <sub>o</sub> = 2100 mA I <sub>o</sub> = 2800 mA ESD-480S420DT I <sub>o</sub> = 3150 mA I <sub>o</sub> = 4200 mA ESD-480S560DT I <sub>o</sub> = 4350 mA I <sub>o</sub> = 5600 mA ESD-480S10ADT I <sub>o</sub> = 7500 mA I <sub>o</sub> = 10000 mA	93.0% 92.0% 92.5% 91.5% 92.0% 91.0% 91.5% 91.0% 91.5% 89.5%	95.0% 94.0% 94.5% 93.5% 94.0% 93.0% 93.5% 93.0% 93.5% 91.5%	- - - - - - - - - -	Measured at 100% load and steady-state temperature in 25°C ambient; (Efficiency will be about 2.0% lower if measured immediately after startup.)
Standby power	-	-	1.5 W	Measured at 480Vac/50Hz; Dimming off
MTBF	-	210,000 Hours	-	Measured at 480Vac input, 80%Load and 25°C ambient temperature (MIL-HDBK-217F)
Lifetime	-	102,000 Hours	-	Measured at 480Vac input, 80%Load and 70°C case temperature; See lifetime vs. Tc curve for the details
Operating Case Temperature for Safety T <sub>c_s</sub>	-40°C	-	+85°C	
Operating Case Temperature for Warranty T <sub>c_w</sub>	-40°C	-	+75°C	Case temperature for 5 years warranty Humidity: 10% RH to 95% RH;
Storage Temperature	-40°C	-	+85°C	Humidity: 5%RH to 100%RH
Dimensions Inches (L × W × H) Millimeters (L × W × H)	9.25 x 4.92 x 1.71 235 x 125 x 43.5			With mounting ear 10.3 x 4.92 x 1.71 262 x 125 x 43.5
Net Weight	-	2650 g	-	

## Dimming Specifications

Parameter	Min.	Typ.	Max.	Notes	
Absolute Maximum Voltage on the V <sub>dim</sub> (+) Pin	-20 V	-	20 V		
Source Current on V <sub>dim</sub> (+)Pin	200 μA	300 μA	450 μA	V <sub>dim</sub> (+) = 0 V	
Dimming Output Range	ESD-480S140DT ESD-480S280DT ESD-480S420DT ESD-480S560DT ESD-480S10ADT	10%I <sub>o</sub> set	-	I <sub>o</sub> set	1050mA ≤ I <sub>o</sub> set ≤ 1400mA 2100mA ≤ I <sub>o</sub> set ≤ 2800mA 3150mA ≤ I <sub>o</sub> set ≤ 4200mA 4350mA ≤ I <sub>o</sub> set ≤ 5600mA 7500mA ≤ I <sub>o</sub> set ≤ 10000mA
	ESD-480S140DT ESD-480S280DT ESD-480S420DT ESD-480S560DT ESD-480S10ADT	105 mA 210 mA 315 mA 435 mA 750 mA	-	I <sub>o</sub> set	105mA ≤ I <sub>o</sub> set < 1050mA 210mA ≤ I <sub>o</sub> set < 2100mA 315mA ≤ I <sub>o</sub> set < 3150mA 435mA ≤ I <sub>o</sub> set < 4350mA 750mA ≤ I <sub>o</sub> set < 7500mA

## Dimming Specifications (Continued)

Parameter	Min.	Typ.	Max.	Notes
Recommended Dimming Input Range	0 V	-	10 V	Default 0-10V dimming mode.
Dim off Voltage	0.35 V	0.5 V	0.65 V	
Dim on Voltage	0.55 V	0.7 V	0.85 V	
Hysteresis	-	0.2 V	-	
PWM_in High Level	3 V	-	10 V	Dimming mode set to PWM in Inventronics Programming Software.
PWM_in Low Level	-0.3 V	-	0.6 V	
PWM_in Frequency Range	200 Hz	-	3 KHz	
PWM_in Duty Cycle	1%	-	99%	
PWM Dimming off (Positive Logic)	3%	5%	8%	
PWM Dimming on (Positive Logic)	5%	7%	10%	
PWM Dimming off ( Negative Logic)	92%	95%	97%	
PWM Dimming on ( Negative Logic)	90%	93%	95%	
Hysteresis	-	2%	-	

## Safety & EMC Compliance

Safety Category	Standard
UL/CUL	UL 8750,CAN/CSA-C22.2 No. 250.13
CE	EN 61347-1, EN61347-2-13
EMI Standards	Notes
EN IEC 55015/KS C 9815 <sup>(1)</sup>	Conducted emission Test & Radiated emission Test
EN IEC 61000-3-2	Harmonic current emissions
EN 61000-3-3	Voltage fluctuations & flicker
FCC Part 15 <sup>(1)</sup>	ANSI C63.4 Class B
	This device complies with Part 15 of the FCC Rules. Operation is subject to the following two conditions: [1] this device may not cause harmful interference, and [2] this device must accept any interference received, including interference that may cause undesired Operation.
EMS Standards	Notes
EN 61000-4-2	Electrostatic Discharge (ESD): 8 kV air discharge, 4 kV contact discharge
EN 61000-4-3	Radio-Frequency Electromagnetic Field Susceptibility Test-RS
EN 61000-4-4	Electrical Fast Transient / Burst-EFT
EN 61000-4-5	Surge Immunity Test: AC Power Line: Differential Mode 6 kV, Common Mode 10 kV <sup>(2)</sup>

## Safety & EMC Compliance (Continued)

EMS Standards	Notes
EN 61000-4-6	Conducted Radio Frequency Disturbances Test-CS
EN 61000-4-8	Power Frequency Magnetic Field Test
EN 61000-4-11	Voltage Dips
EN 61547/KS C 9547	Electromagnetic Immunity Requirements Applies To Lighting Equipment

- Notes:** (1) This LED driver meets the EMI specifications above, but EMI performance of a luminaire that contains it depends also on the other devices connected to the driver and on the fixture itself.
- (2) To perform electric strength (hi-pot) testing, the “GDT ground disconnect” (nut and metal lock sheet) on the driver end-cap should be removed temporarily to prevent the internal gas discharge tube from conducting (as allowed by IEC 60598-1 Clause 10.2). After testing is completed, these items must be reinstalled to restore line-to-earth surge protection and secure the end cap.

## Lifetime vs. Case Temperature

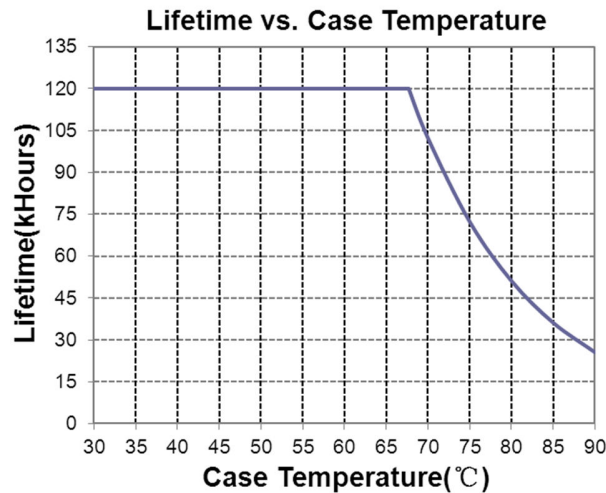

## Inrush Current Waveform

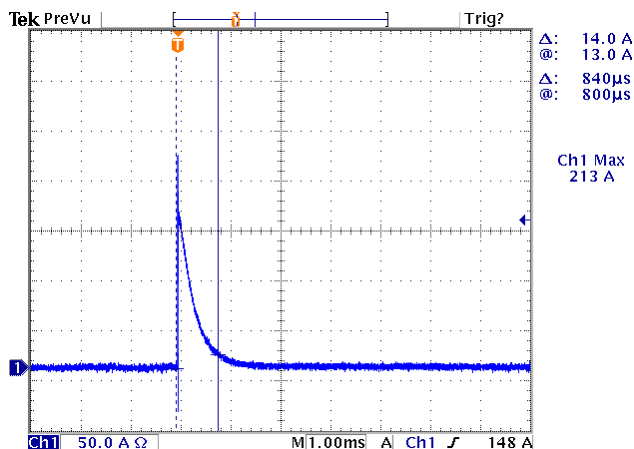

## Efficiency vs. Load

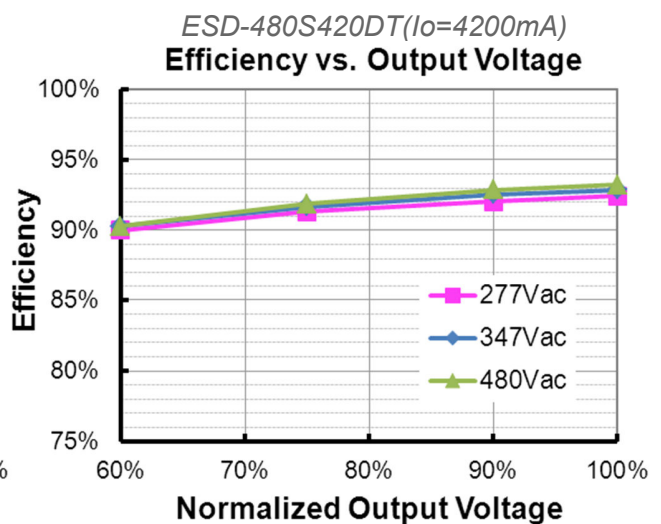
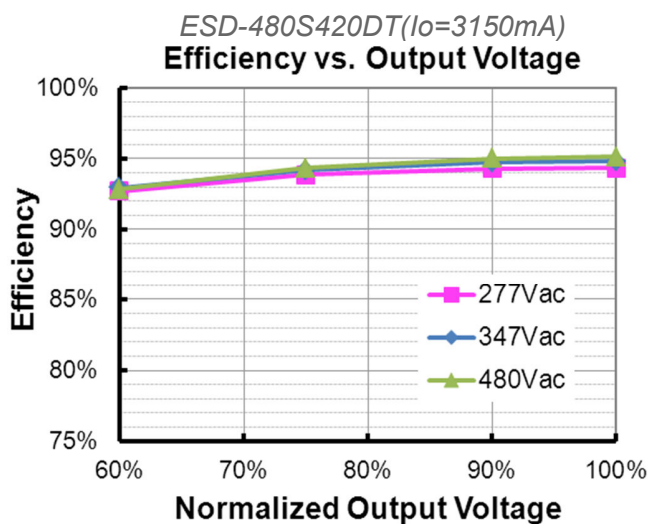
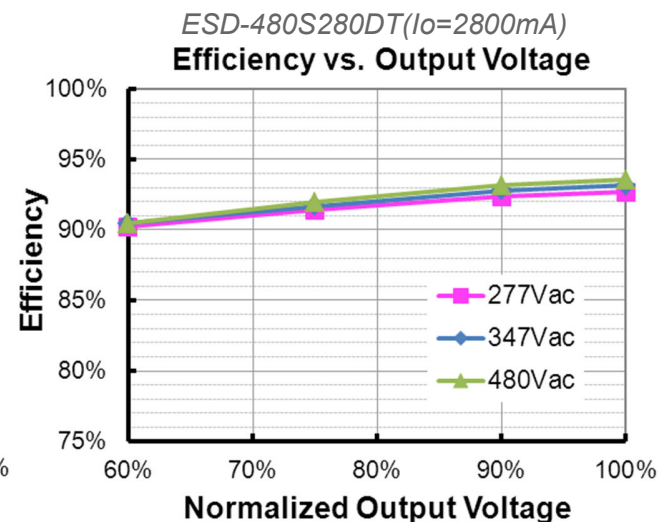
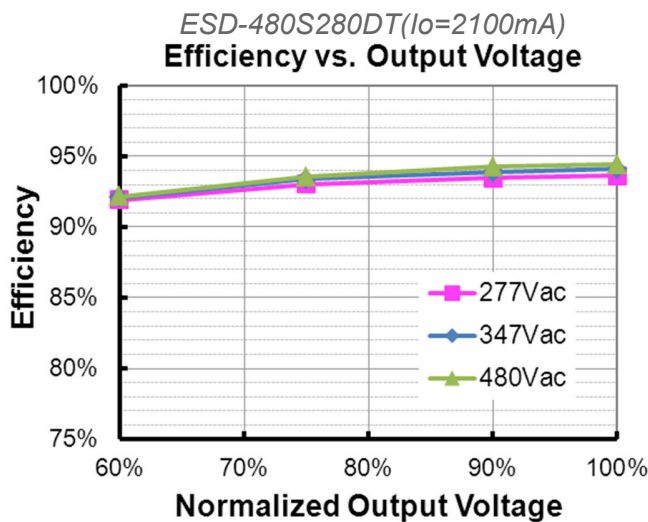
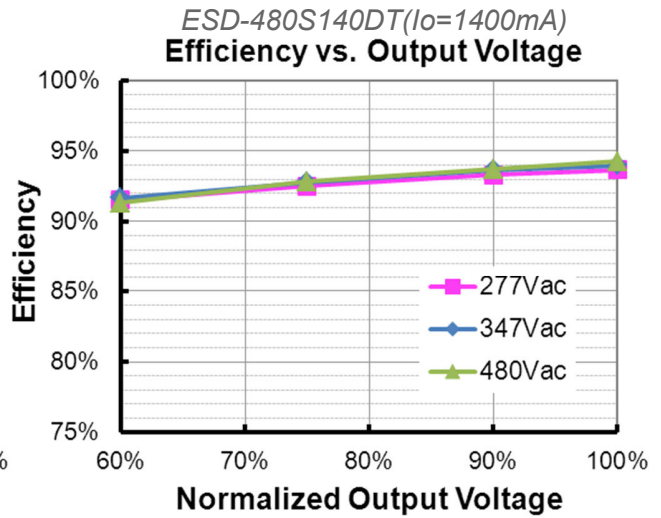
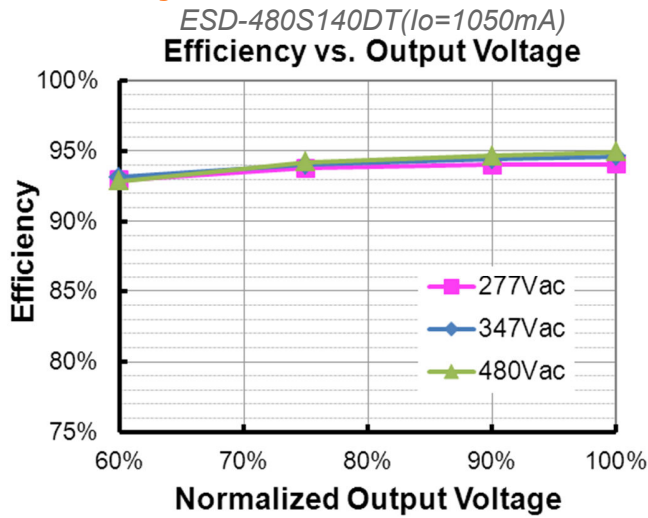

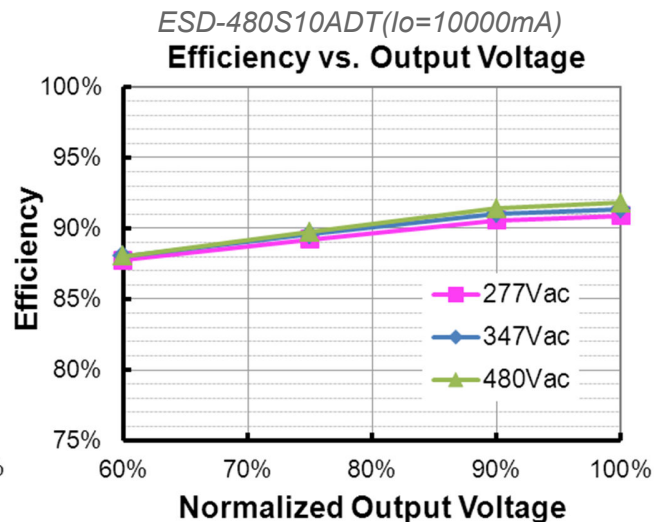
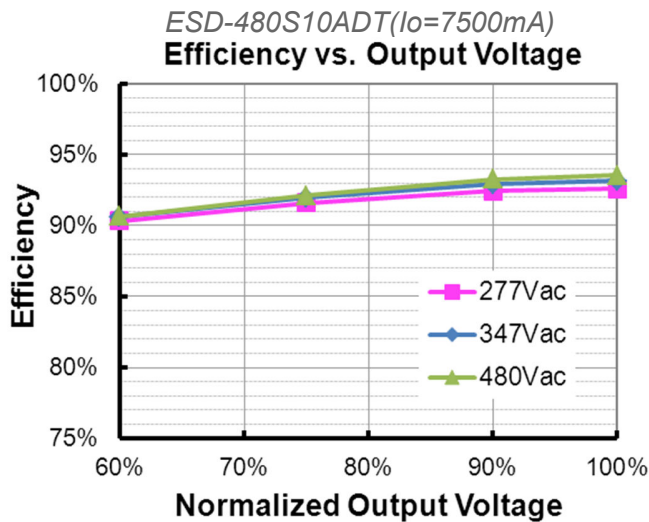
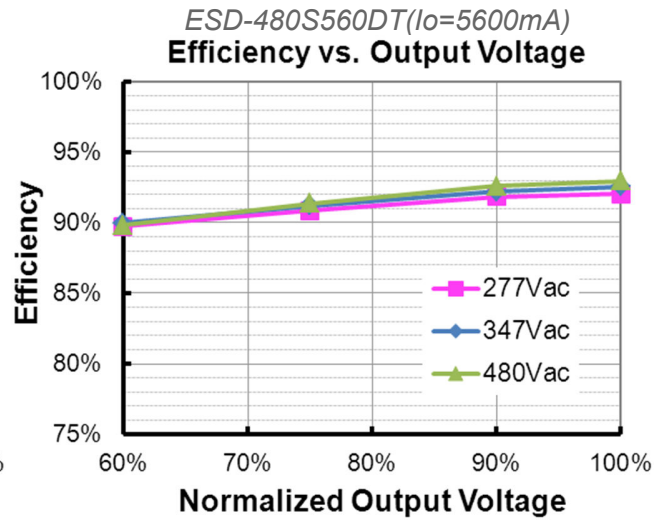
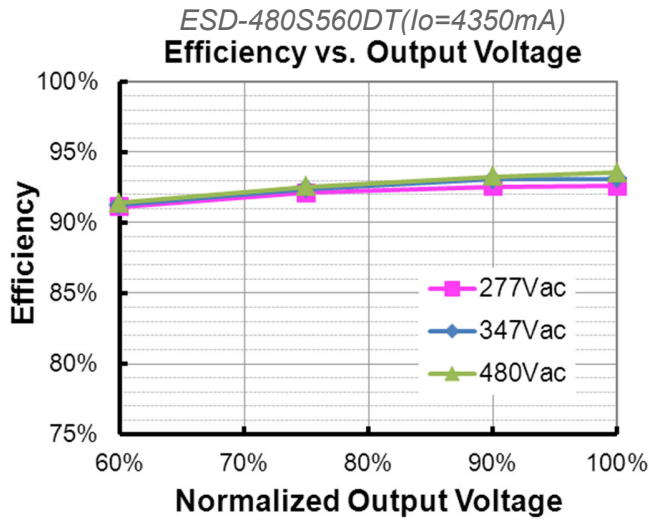

## Power Factor

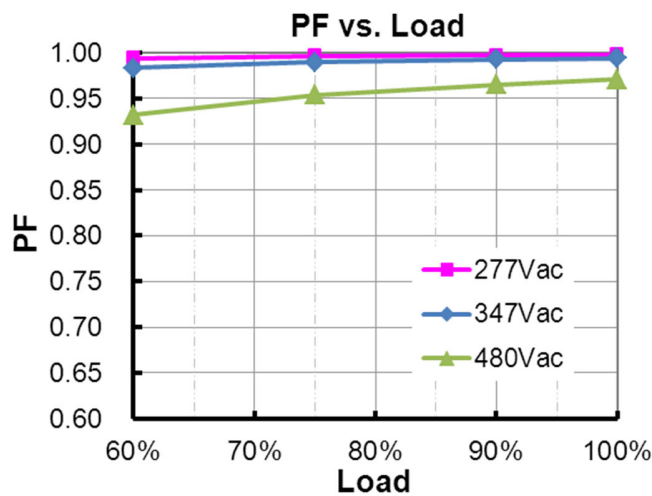

## Total Harmonic Distortion

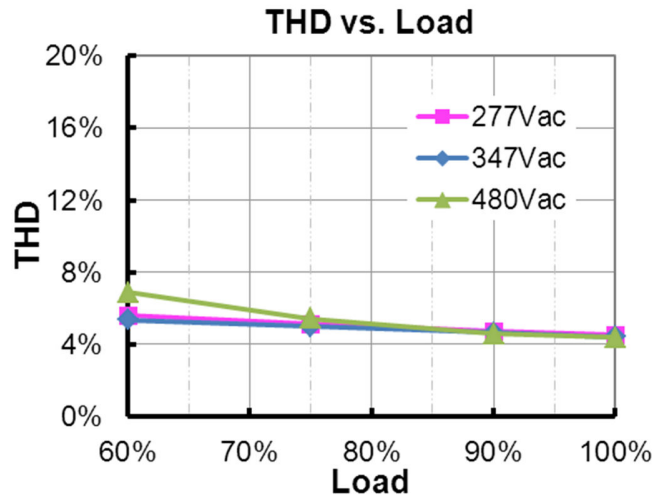

## Protection Functions

Parameter		Min.	Typ.	Max.	Notes
External Thermal Protection NTC	R1	-	7.81 kOhm	-	When R_NTC falls below R1, External Thermal Protection is triggered, reducing output current until R2 is reached.
	R2	-	4.16 kOhm	-	When R_NTC is less than R2, output current is reduced to the programmed "Protection Current Floor."
	Protection Current Floor	10%loset Iomin	60%loset 60%loset	100%loset 100%loset	10%loset>Iomin (default setting is 60%) 10%loset≤Iomin (default setting is 60%)
Over Temperature Protection		Decreases output current, returning to normal after over temperature is removed.			
Short Circuit Protection		Auto Recovery. No damage will occur when any output is short circuited. The output shall return to normal when the fault condition is removed.			
Over Voltage Protection		Limits output voltage at no load and in case the normal voltage limit fails.			

## Dimming

### ● 0-10V Dimming

The recommended implementation of the dimming control is provided below.

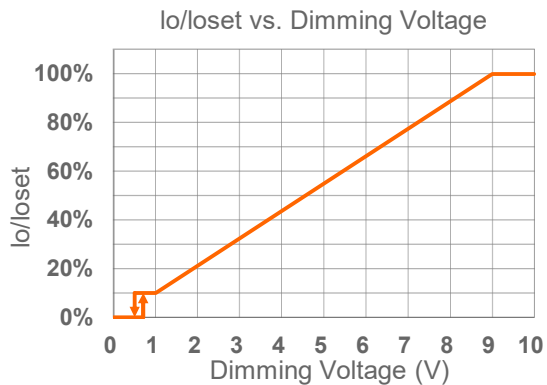
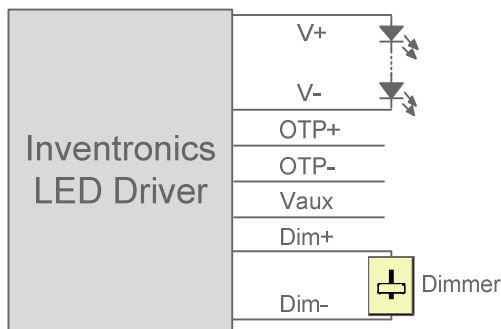

### Implementation 1: DC Input

**Notes:**

1. Do NOT connect Dim- to the output V- or V+, otherwise the driver will not work properly.
2. The dimmer can also be replaced by an active 0-10V voltage source signal or passive components like zener.

● **PWM Dimming**

The recommended implementation of the dimming control is provided below.

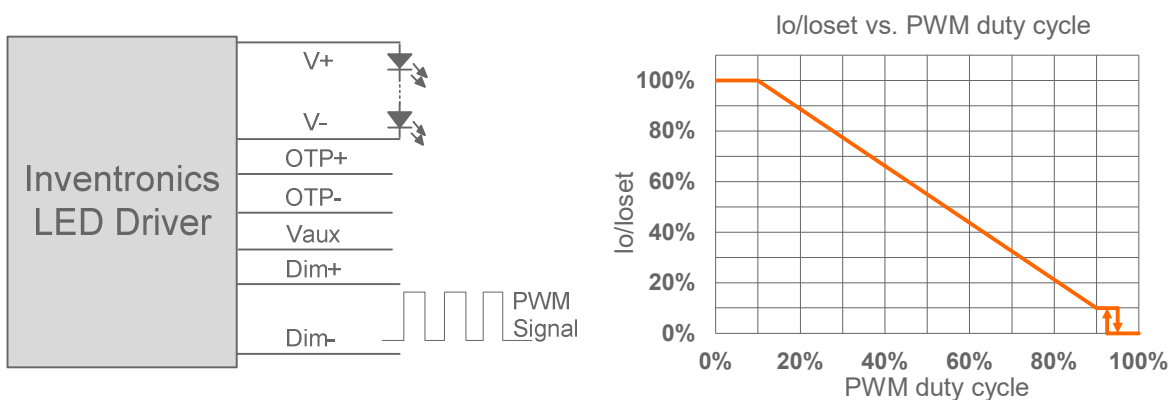
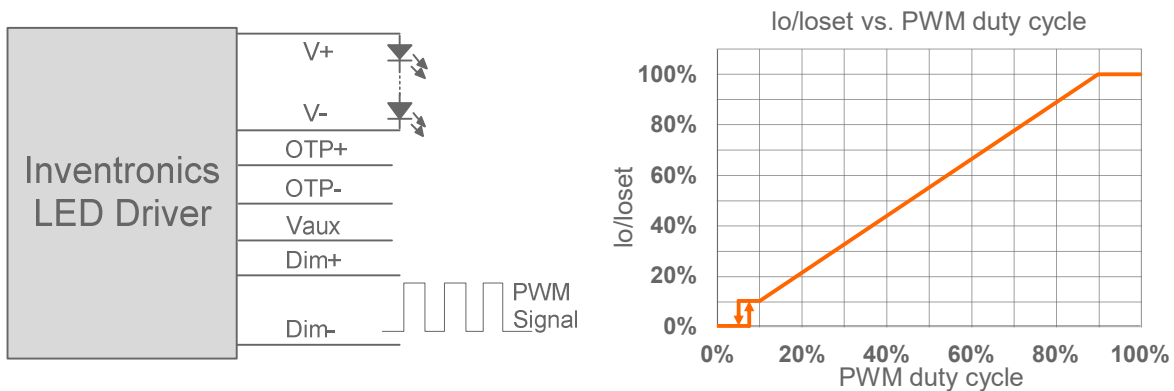

**Notes:**

1. Do NOT connect Dim- to the output V- or V+, otherwise the driver will not work properly.
2. When PWM negative logic dimming mode and Dim+ is open, the driver will dim to off and be standby.

● **Time Dimming**

Time dimming control includes 3 kinds of modes, they are Self Adapting-Midnight, Self Adapting-Percentage and Traditional Timer.

- **Self Adapting-Midnight:** Automatically adjusts the dimming curve based on the on-time of past two days (if difference <15 minutes), assuming that the center point of the dimming curve is midnight local time.
- **Self Adapting-Percentage:** Automatically adjusts the on-time of each step by a constant percentage = (actual on-time for the past 2 days if difference <15 min) / (programmed on-time from the dimming curve).
- **Traditional Timer:** Follows the programmed timing curve after power on with no changes.

## ● Output Lumen Compensation

Output Lumen Compensation (OLC) may be used to maintain constant light output over the life of the LEDs by driving them at a reduced current when new, then gradually increasing the drive current over time to counteract LED lumen degradation.

## Programming Connection Diagram

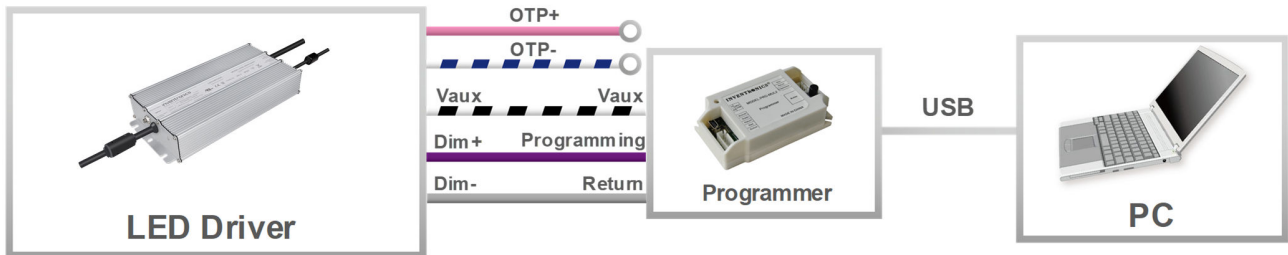

**Note:** The driver does not need to be powered on during the programming process.

● Please refer to [PRG-MUL2](#) (Programmer) datasheet for details.

## Mechanical Outline

ESD-480S140DT

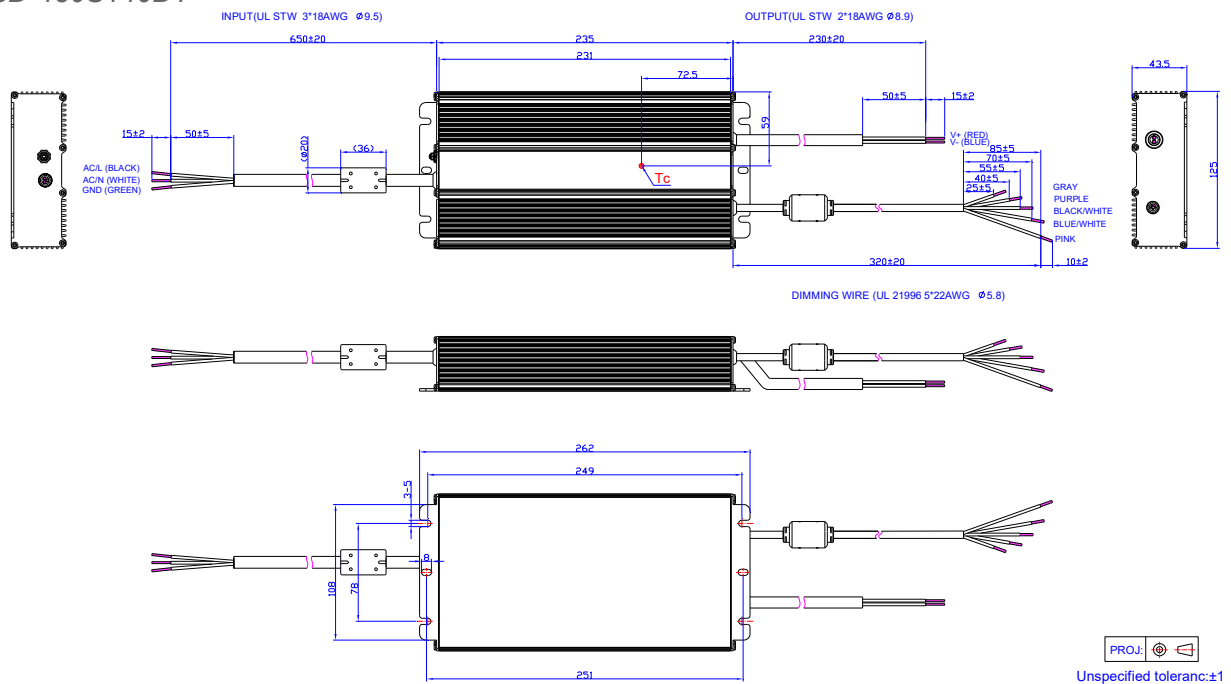

## Other Models

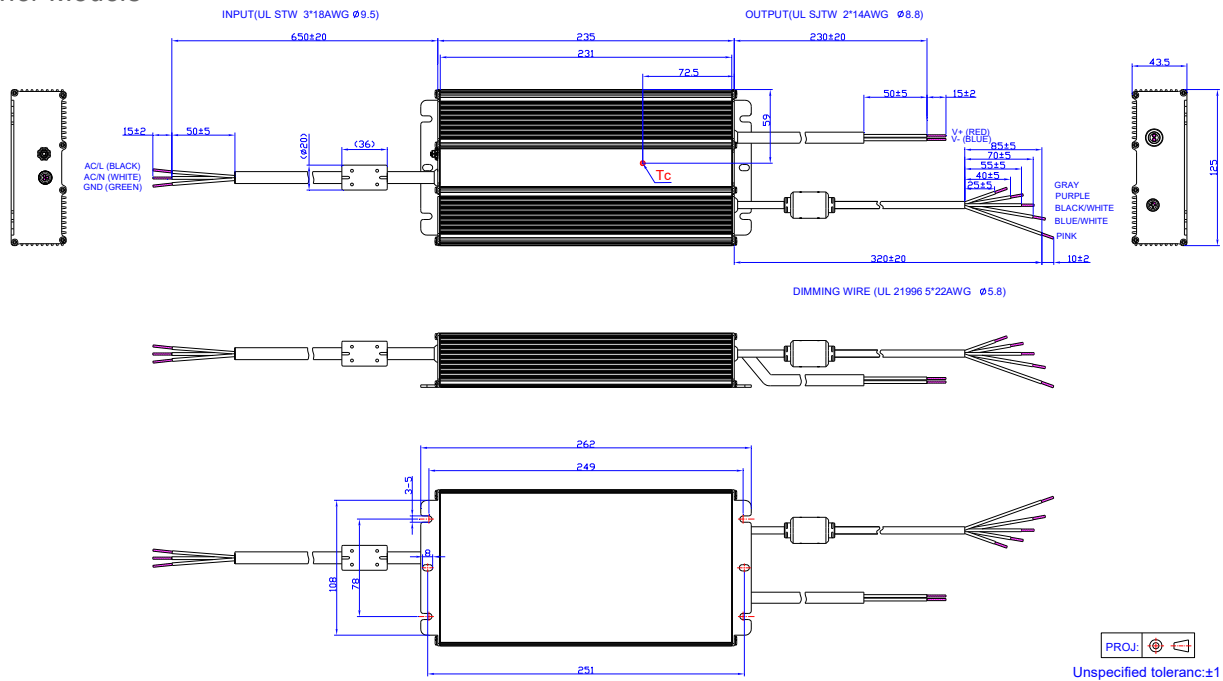

## RoHS Compliance

Our products comply with reference to RoHS Directive (EU) 2015/863 amending 2011/65/EU, calling for the elimination of lead and other hazardous substances from electronic products.

## Revision History

Change Date	Rev.	Description of Change		
		Item	From	To
2019-01-17	A	Datasheet Release	/	/
2019-12-02	B	Features	6kV line-line, 10kV line-earth	DM 6kV, CM 10kV
		Features	Waterproof (IP67)	IP67
		I-V Operating Area- ESD-480S280DT	/	Updated
		Safety &EMC Compliance	EN 61000-4-5	Updated
		RoHS Compliance	/	Updated
2020-11-05	C	Format	/	Updated
		Models	Power Factor	Updated
2020-11-20	D	Models	Power Factor	Updated
		Input Specifications	Input AC Voltage	Updated
		Input Specifications	Input DC Voltage	Updated
		General Specifications	Operating Case Temperature for Warranty T <sub>c_w</sub>	Updated
2026-03-25	E	Format	/	Updated
		Product photograph	/	Updated
		KCC logo	/	Added
		Models	/	Updated
		Safety &EMC Compliance	/	Updated